

KATALOG

KATALOG
 KATALÓG
 KATALOG
 KATALOGUS
 CATALOG
 КАТАЛОГ
 KATALOG
 CATALOGO
 CATALOGUE
 KATALOG

domax



domax.com

AKG	1.03	NA	2.36	WR	4.34
ANG	1.01	NAD	2.37	WRG	4.37
APG	1.02	NAO	2.37	WSP	4.36
BIT	5.06	NS	4.41	WZP	4.30
C	4.17	NT	2.26	WZTW	4.29
CK	5.04	OP	3.14	WZW	4.31
CM	4.19	PC	6.02	XDR	7.05
CS	5.01, 5.02	PD	2.40	XGM	7.02
CT	5.03	PK 10	2.44	XKR	7.12
CW	4.18	PK 15	2.42, 2.43	XKRZ	7.13
DK	3.12	PKN	6.05	XLG	7.11
KB	2.03	PKR	6.04	XLJ	7.04
KG	2.33	PP	2.20, 2.21	XPPF	7.01
KK	2.15	PPL	6.01	XSK	7.06
KKB	2.07	PRK	6.06	XSM	7.03
KL	2.14	PRO	6.08	XSP	7.07
KLM	2.38	PRP	6.07	XSR	7.14
KLR	2.06	PS	3.06	XSS	7.08
KM	2.12	PSG	3.01	XST	7.09
KMP	2.13	PSL	3.07	XSW	7.10
KMR	2.17	PSO	3.09	XSZ	7.16
KMRP	2.17	PSP	3.03	XZL	7.15
KP	2.04, 2.05	PSPDX	3.04	Z	4.02
KPK 11,12,13	2.08	PSPO	3.02	ZB	4.09
KPK 21,22,23	2.09	PSR	3.10	ZBD	4.07
KPK 31,32,33	2.10	PST	3.05	ZBL	4.12
KPK 4	2.11	PSW	3.08	ZBNO	4.11
KPL	2.04, 2.05	PT	6.03	ZBO	4.10
KR	2.16	PTS	5.06	ZBP	4.13
KRD	2.18	PWD	1.04	ZBW	4.09
KS	2.02	PZD	2.39	ZF	4.04
KSO	2.02	SD	2.46, 2.47	ZFD	4.06
KT	2.25	SK	2.35	ZHK	4.43
KW	2.01	ST	4.46	ZN	4.15
KWO	2.01	TM	2.27	ZO	4.03
KWZ	3.11	UD	3.13	ZP	4.16
LB	2.19	UN	4.45	ZR	4.14
LBO	3.15	US	4.44	ZRDP	4.25
LG	2.24	W	4.28	ZRM	4.27
LK	2.32	WB	2.28, 2.29	ZRP	4.14
LP	2.22	WBD	2.28	ZRS	4.24
LW	2.23	WBR	4.38	ZRW	4.26
LZ	2.34	WBZ	2.30	ZS	4.01
MHA	3.16	WCZ	4.39	ZSK	4.42
MHB	3.16	WKT	5.05	ZT	4.08
MHC	3.17	WL	2.31	ZTD	4.07
MHD	3.17	WO	4.32	ZTK	4.40
MHK	3.18	WOG	4.35	ZTO	4.07
MHO	3.18	WOS	4.33	ZTS	4.05
		WP	4.28	ZTSD	4.06
				ZZB	4.21
				ZZBR	4.20
				ZZK	4.22
				ZZP	4.23



ANG 1.01



APG 1.02



AKG 1.02



PWD 1.04

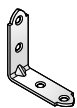

KW 2.01

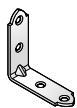

KWO 2.01

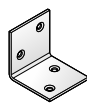

KS 2.02

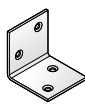

KSO 2.02

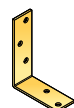

KB 2.03



KP 2.04, 2.05



KPL 2.04, 2.05



KLR 2.06



KKB 2.07



KPK 2.08



KPK 2.09



KPK 2.10



KPK 2.11



KM 2.12



KMP 2.13



KL 2.14



KK 2.15



KR 2.16



KMR 2.17



KMRP 2.17



KRD 2.18



LB 2.19

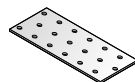

PP 2.20, 2.21

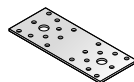

LP 2.22



LW 2.23



LG 2.24



KT 2.25

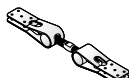

NT 2.26



TM 2.27



WBD 2.28



WB 2.28, 2.29



WBZ 2.30



WL 2.31



LK 2.32



KG 2.33



LZ 2.34



SK 2.35



NA 2.36



NAD 2.37



NAO 2.37



KLM 2.38



PZD 2.39



PD 2.40



PK 2.42, 2.43, 2.44



SD 2.46, 2.47



SDS 2.48



PSG 3.01



PSPO 3.02



PSP 3.03



PSPDX 3.04



PST 3.05



PS 3.06



PSL 3.07



PSW 3.08



PSO 3.09



PSR 3.10



KWZ 3.11



DK 3.12



UD 3.13



OP 3.14



LBO 3.15



MHA 3.16



MHB 3.16



MHC 3.17



MHD 3.17



MHK 3.18



MHO 3.18



ZS 4.01



Z 4.02



ZO 4.03



ZF 4.04



ZTS 4.05



ZFD 4.06



ZTSD 4.06



ZBD 4.07



ZTD 4.07



ZTO 4.07



ZT 4.08



ZB 4.09



ZBW 4.09



ZBO 4.10



ZBNO 4.11



ZBL 4.12



ZBP 4.13



ZR 4.14



ZRP 4.14



ZN 4.15



ZP 4.16



C 4.17



CW 4.18



CM 4.19



ZZBR 4.20



ZB 4.21



ZZK 4.22



ZZP 4.23



ZRS 4.24



ZRDP 4.25



ZRW 4.26



ZRM 4.27



W 4.28



WP 4.28



WZTW 4.29



WZP 4.30



ZWZ 4.31



WRO 4.32



WOS 4.33



WR 4.34



WOG 4.35



WSP 4.36



WRG 4.37



WBR 4.38



WCZ 4.39



ZTK 4.40



NS 4.41



ZSK 4.42



ZHK 4.43



US 4.44



UN 4.45



ST 4.46



CS 5.01, 5.02



CT 5.03



CK 5.04



WKT 5.05



PTS 5.06



BIT 5.06

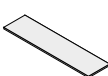

PPL 6.01



PC 6.02



PT 6.03

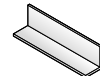

PKR 6.04

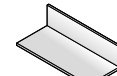

PKN 6.05



PRK 6.06

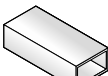

PRP 6.07



PRO 6.08



XPPF 7.01



XGM 7.02



XSM 7.03



XLJ 7.04



XDR 7.05



XSK 7.06



XSP 7.07



XSS 7.08



XST 7.09



XSW 7.10



XLG 7.11



XKR 7.12



XKRZ 7.13



XSR 7.14



XZL 7.15



XSZ 7.16



GWOŹDZIE I WKRETY

HŘEBÍKY

KLINCE A VRUTY

EKSERI&SRAFOVI

SZÖGEK ÉS CSAVAROK

CUIE SI HOLT-SURUBURI

ГВОЗДИ И САМОРЕЗЫ

ПИРОНИ И БОЛТОВЕ

CLAVOS Y TORNILLOS

NAILS & SCREWS

CLOUS ET VIS

NÄGEL UND SCHRAUBEN

dmxsystem.com



Gwoździec anchor • Hřebíky tesařské anchor • Klince tesárske anchor
 Anker ekser • Bordás szeg • Cui anchor
 Гвозди анкер • Анкерен пирон • Clavos de anclaje
 Anchor nail • Clou d'ancrage • Nagel

ANG

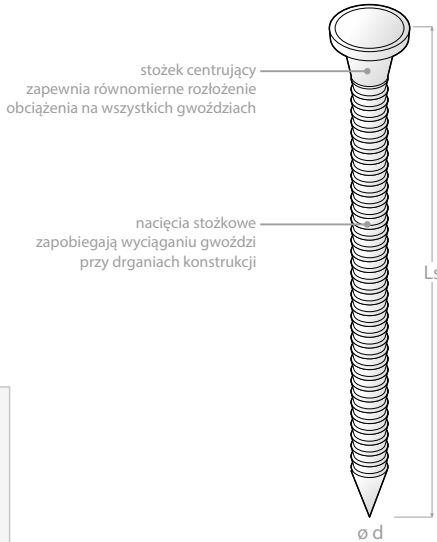

Gwoździec karbowane ANCHOR są jedynymi gwoździemi dopuszczonymi do mocowania złącz metalowych do drewna, zapewniając właściwy docisk.

Wymagane przez ITB dla uzyskania połączenia objętego Aprobatacją Techniczną.

Recommended by the ITB Institute to provide the connection described in the Technical Approval.

SYMBOL	art. №		[mm]		📦	📦
	new	old	Ls	ø d		
ANG 35	3871	490101	35	4,0	1033 g	261 pcs.
ANG 35 / 50	38715	490151	35	4,0	198 g	50 pcs.
ANG 40	3872	490201	40	4,0	1033 g	226 pcs.
ANG 40 / 50	38725	490251	40	4,0	228 g	50 pcs.
ANG 40 / 5 kg	38726	490261	40	4,0	5100 g	1130 pcs.
ANG 50	3873	490301	50	4,0	1033 g	195 pcs.
ANG 50 / 30	38733	490351	50	4,0	159 g	30 pcs.
ANG 50 / 5 kg	38736	490361	50	4,0	5100 g	975 pcs.
ANG 60	3874	490401	60	4,0	1033 g	158 pcs.
ANG 60 / 30	38743	490451	60	4,0	196 g	30 pcs.
ANG 60 / 5 kg	38746	490461	60	4,0	5100 g	790 pcs.
ANG 75	3875	490501	75	4,0	1033 g	113 pcs.
ANG 75 / 30	38753	490551	75	4,0	274 g	30 pcs.
ANG 100	3876	490601	100	4,0	1030 g	99 pcs.
ANG 125	3877	490701	125	4,0	1033 g	80 pcs.

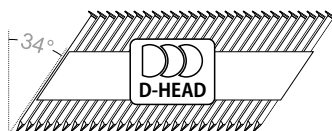
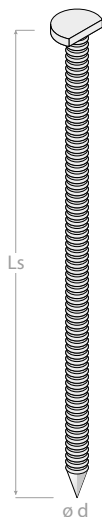

Gwoździe APG DMX® pasują do następujących narzędzi:

TJEP GRF 34/105 GAS; GRF 34/90 GAS; GN 34/100; GN 100 Compact XP; GN 100 Compact; GN 100
Paslode PSN100; F-400; F-350; GN 5350; IM350/90; IM90i; PSN98; IM100i
Senco FB652; SP800; STN130
MAX GS-690 RH

SYMBOL	art. № new	[mm]			
		Ls	ød		
APG 28/50	371350	50	2,8	-	4000 pcs.
APG 28/65	371365	65	2,8	-	3000 pcs.
APG 28/75	371375	75	2,8	-	2000 pcs.
APG 31/90	371390	90	3,1	-	2000 pcs.
APG 31/100	371399	100	3,1	-	2000 pcs.
APGs 31/90	371490	90	3,1	-	2000 pcs.

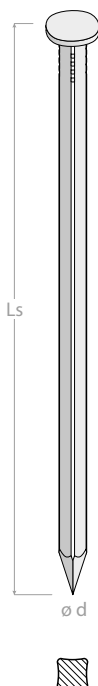



kwadratowy profil trzpienia



- unikalny kształt czerpiący z bogatych doświadczeń budowlanych krajów skandynawskich
- zwiększa odporność gwoźdza na zginanie
- podwyższa podstawowe parametry techniczne (siła ścinająca i wyrywająca)
- zapewnia 25-30% większą liczbę gwoździ przypadającą na jeden kilogram

powłoka galwaniczna Dura.HDG 50 µm

- ponadprzeciętna ochrona antykorozyjna
- ekonomiczne rozwiązanie w stosunku do droższych gwoździ nierdzewnych
- nowoczesna technologia oraz ścisła kontrola produkcji zapewnia stabilną jakość powłoki
- zwiększona wartość siły wyrywającej

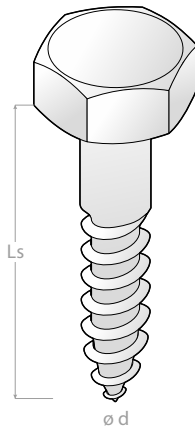
SYMBOL	art. № new	[mm]			
		Ls	ø d		
AKG 28/75	3862	75	2,8	5,0 kg	-
AKG 34/100	3863	100	3,4	5,0 kg	-
AKG 40/125	3864	125	4,0	5,0 kg	-



SYMBOL	art. №		[mm]			
	new	old	Ls	ø d		
PWD 10/50	3891	493101	50	10	1030 g	1 à 30 pcs.
PWD 10/60	3892	493201	60	10	1030 g	1 à 28 pcs.



ŁĄCZNIKI DO DREWNA

SPOJOVACÍ PRVKY DŘEVA

SPOJOVACIE PRVKY DREVA

KONEKTORI

ÖSSZEKOTÓK

RACORDURI PENTRU LEMN

СОЕДИНЕНИЯ ДЕРЕВЯННЫХ КОНСТРУКЦИЙ

СКРЕПИТЕЛНИ ЕЛЕМЕНТИ ЗА ДЪРВЕНИ КОНСТРУКЦИИ

CONECTORES PARA MADERA

CONNECTORS

CONNECTEURS POUR BOIS

HOLZVERBINDER

dmxsystem.com



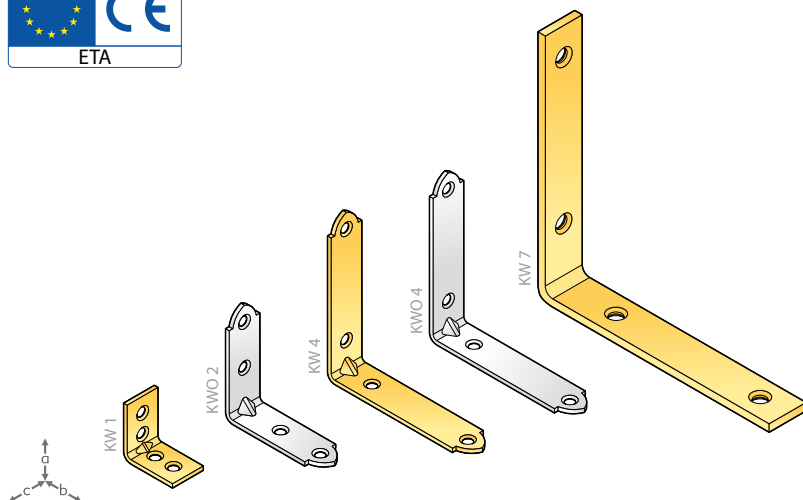

symbol	art. №		[mm]				qty \emptyset		🧴	📦	F↓
	new	old	≠	a	b	c	ø4,5	ø6			
KW 1	4001	400101	1,5	25	25	17	4	-	9 g	50 pcs.	3,33 kN
KW 1 / 4	400102	425001	1,5	25	25	17	4	-	35 g	40 à 4 pcs.	3,33 kN
KW 1 / 12	400105	425101	1,5	25	25	17	4	-	106 g	30 à 12 pcs.	3,33 kN
KW 2	4002	400201	1,5	40	40	17	4	-	14 g	50 pcs.	3,33 kN
KW 2 / 4	400202	425201	1,5	40	40	17	4	-	54 g	30 à 4 pcs.	3,33 kN
KW 2 / 12	400205	425301	1,5	40	40	17	4	-	163 g	20 à 12 pcs.	3,33 kN
KW 2 / 24	400206	425401	1,5	40	40	17	4	-	326 g	14 à 24 pcs.	3,33 kN
KW 3	4003	400301	2,0	50	50	17	4	-	23 g	20 pcs.	3,33 kN
KW 3 / 4	400302	425501	2,0	50	50	17	4	-	93 g	20 à 4 pcs.	3,33 kN
KW 3 / 12	400305	425601	2,0	50	50	17	4	-	278 g	15 à 12 pcs.	3,33 kN
KW 4	4004	400401	2,0	75	75	17	4	-	38 g	20 pcs.	3,33 kN
KW 4 / 4	400402	427801	2,0	75	75	17	4	-	169 g	10 à 4 pcs.	3,33 kN
KW 4 / 8	400404	427701	2,0	75	75	17	4	-	300 g	10 à 8 pcs.	3,33 kN
KW 4 / 12	400405	427901	2,0	75	75	17	4	-	507 g	24 à 12 pcs.	3,33 kN
KW 5	4005	400501	4,0	100	100	20	-	4	112 g	20 pcs.	3,33 kN
KW 5 / 8	400504	425701	4,0	100	100	20	-	4	896 g	1 à 8 pcs.	3,33 kN
KW 6	4006	400601	4,0	125	125	20	-	4	154 g	20 pcs.	3,33 kN
KW 7	4007	400701	5,0	150	150	25	-	4	290 g	20 pcs.	3,33 kN
KWO 1	40014	400141	1,5	25	25	17	4	-	9 g	50 pcs.	3,33 kN
KWO 2	40024	400241	1,5	40	40	17	4	-	14 g	50 pcs.	3,33 kN
KWO 3	40034	400341	2,0	50	50	17	4	-	23 g	20 pcs.	3,33 kN
KWO 4	40044	400441	2,0	75	75	17	4	-	37 g	20 pcs.	3,33 kN

KW 1-4: DC01 electrogalvanized
 KW 5-7: S235 electrogalvanized
 KWO: DX51D + Z275MAC

tested by ITB ↑

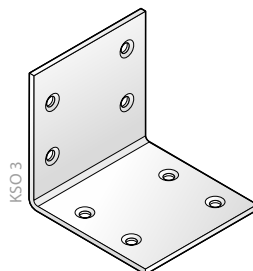
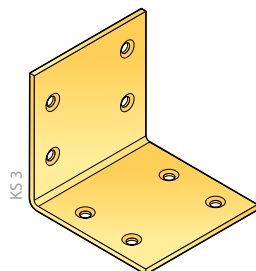
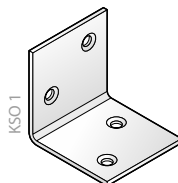
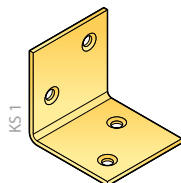

KS1/12



symbol	art. №		[mm]				qty \emptyset $\emptyset 4,5$			F \downarrow
	new	old	\pm	a	b	c				
KS 1	4011	401101	1,5	30	30	30	4	20 g	50 pcs.	3,44 kN
KS 1 /4	401102	427601	1,5	30	30	30	4	80 g	30 à 4 pcs.	3,44 kN
KS 1 /12	401105	428301	1,5	30	30	30	4	240 g	15 à 12 pcs.	3,44 kN
KS 1 /24	401206	425801	1,5	30	30	30	4	480 g	5 à 24 pcs.	3,44 kN
KS 2	4012	401201	1,5	40	40	40	4	36 g	50 pcs.	3,44 kN
KS 2 /4	401202	428401	1,5	40	40	40	4	144 g	25 à 4 pcs.	3,44 kN
KS 2 /12	401205	428501	1,5	40	40	40	4	432 g	20 à 12 pcs.	3,44 kN
KS 3	4013	401301	2,0	60	60	60	8	109 g	20 pcs.	6,65 kN
KS 3 /12	401305	425901	2,0	60	60	60	8	1308 g	5 à 12 pcs.	6,65 kN
KSO 1	40114	401141	1,5	30	30	30	4	20 g	50 pcs.	3,49 kN
KSO 2	40124	401241	1,5	40	40	40	4	36 g	50 pcs.	3,49 kN
KSO 3	40134	401341	2,0	60	60	60	8	109 g	20 pcs.	6,58 kN



KS: DC01 electrogalvanized
KSO: DX51D + Z275MAC

tested by ITB \uparrow

Kařtownik belki • Úhelník trmov • Uholník trmov
 Ugaona spojnica • Szegletvas erstett • řablon de unghiuri de grind
 Угол балочный • Ёглова планка за дограма • Escuadra para viga
 Joist square • Cornire de renfort pour solive • Balkenwinkel

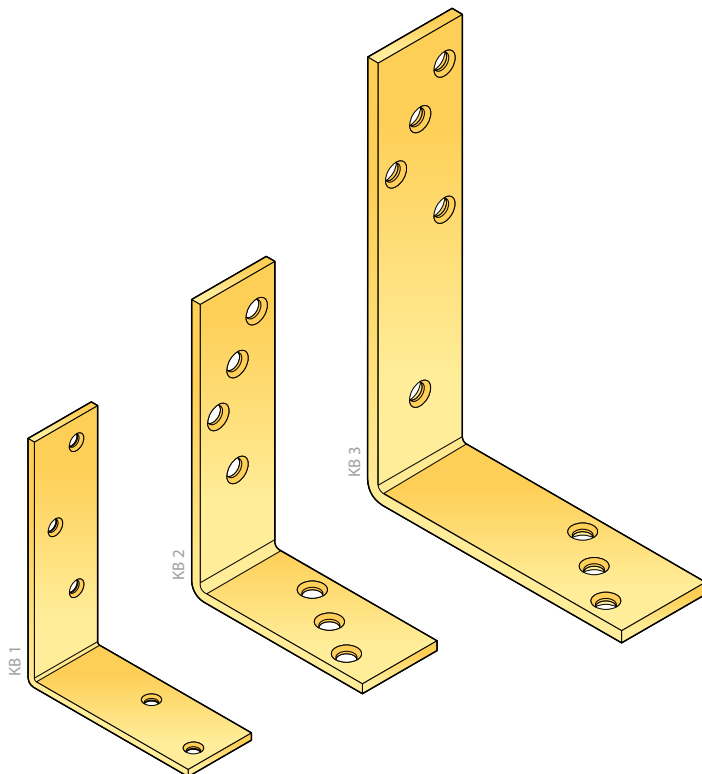
KB



symbol	art. N		[mm]				qty 				F ↓
	new	old	±	a	b	c	4,5	7			
KB 1	4015	401501	3,0	100	75	30	5	-	120 g	20 pcs.	7,46 kN
KB 2	4016	401601	4,0	120	80	35	-	7	196 g	10 pcs.	8,62 kN
KB 3	4017	401701	5,0	180	120	40	-	8	448 g	10 pcs.	8,62 kN

S235 electrogalvanized

tested by ITB †

2.03

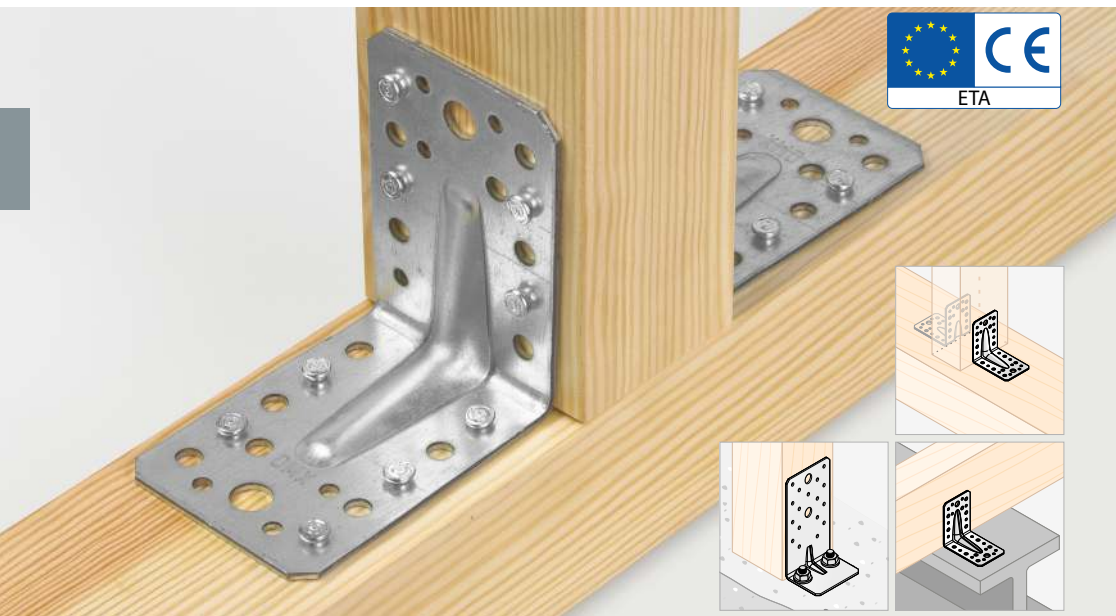

symbol	art. №		[mm]				qty ø				🧴	📦	F ↓
	new	old	≠	a	b	c	ø5	ø7	ø11	ø14			
KP 1	4021	402101	2,5	90	90	65	16	12	2	-	209 g	20 pcs.	17,80 kN
KP 2	4022	402201	2,5	105	105	90	36	-	-	2	347 g	20 pcs.	21,90 kN
KP 3	4023	402301	2,5	90	50	55	20	-	2	-	140 g	20 pcs.	14,35 kN
KP 4	4024	402401	2,5	70	70	55	20	-	2	-	140 g	20 pcs.	10,45 kN
KP 5	4025	405101	2,5	140	140	65	26	-	2	-	338 g	10 pcs.	10,92 kN
KP 6	4026	405301	3	172	105	90	44	-	7	2	512 g	10 pcs.	21,89 kN
NEW KP 7	4027	403901	2,5	145	145	90	56	-	-	8	226 g	10 pcs.	-
NEW KP 8	4028	404001	2,5	145	70	90	17	-	-	4	343 g	10 pcs.	-
KP 11	40211	405501	2,5	90	90	65	13	9	5	-	209 g	20 pcs.	-
KP 21	40221	405601	2,5	105	105	90	28	-	4	1	337 g	20 pcs.	-
KPL 1	4051	402601	2	90	90	65	16	12	2	-	170 g	20 pcs.	17,80 kN
KPL 1 /12	405105	426001	2	90	90	65	16	12	2	-	2040 g	1 à 12 pcs.	17,80 kN
KPL 2	4052	402701	2	105	105	90	36	-	-	2	280 g	20 pcs.	21,90 kN
KPL 2 /12	405205	426101	2	105	105	90	36	-	-	2	3360 g	1 à 12 pcs.	21,90 kN
KPL 3	4053	402801	2	90	50	55	20	-	2	-	101 g	20 pcs.	14,35 kN
KPL 4	4054	402901	2	70	70	55	20	-	2	-	101 g	20 pcs.	10,45 kN
NEW KPL 5	4055	406001	2	50	50	35	8	-	2	-	55 g	20 pcs.	-
NEW KPL 6	4056	406101	2	60	60	45	12	-	2	-	91 g	20 pcs.	-
KPL 11	40511	405701	2	90	90	65	28	-	4	1	209 g	20 pcs.	-
KPL 21	40521	405801	2	105	105	90	16	12	2	-	280 g	20 pcs.	-

DX51D + Z275MAC

tested by ITB ↑

Kątownik z przetłoczeniem • Úhelník s prolisem • Uholník s prelisom
 Montážna spojnica • Sarokösszekötő lemez erősített • Şablon de unghiuri cu suprapresare
 Уголок усиленный • Ёглова планка, оребрена (усилена) • Escuadra reforzada
 Reinforced square • Cornière renforcée • Schwerlast-Winkelverbinder mit Sicke

KP

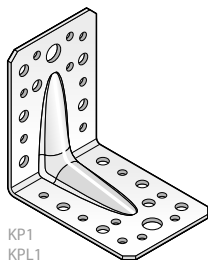

KP1
KPL1

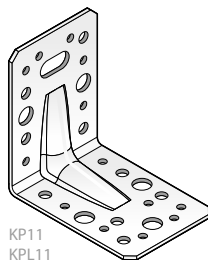

KP11
KPL11

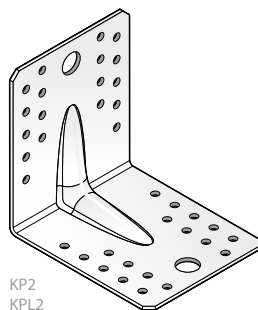

KP2
KPL2

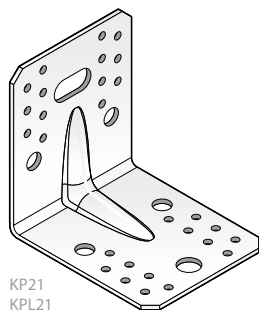

KP21
KPL21

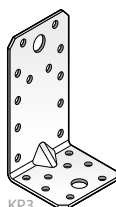

KP3
KPL3

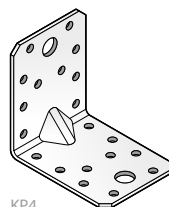

KP4
KPL4

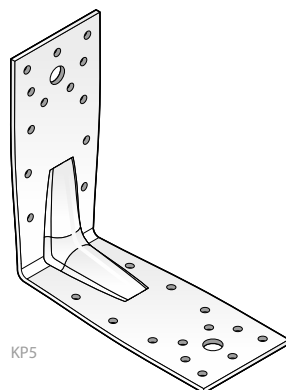

KP5

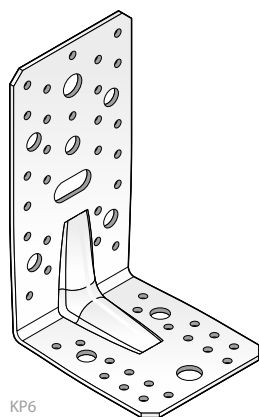

KP6

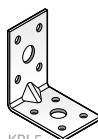

KPL5

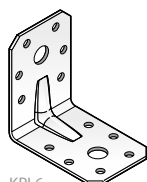

KPL6

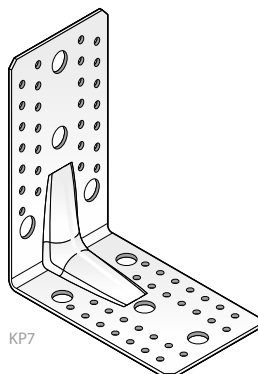

KP7

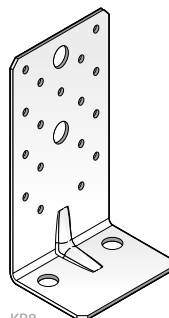

KP8

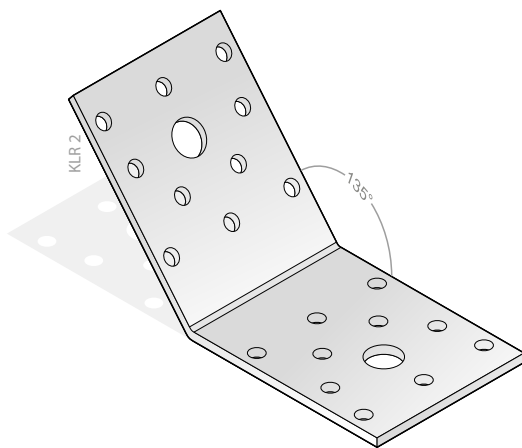
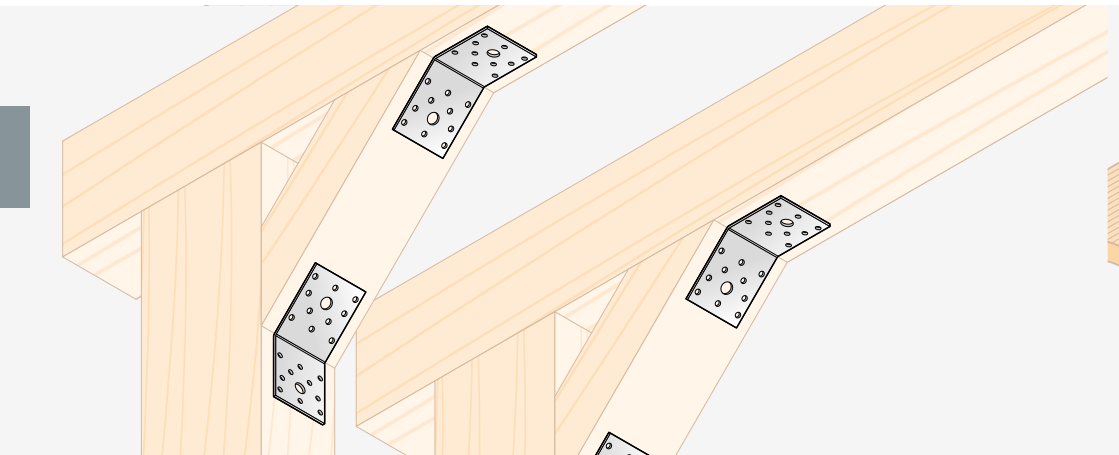

symbol	art. №		[mm]				qty ø				📦	F ↓	
	new	old	≠	a	b	c	ø5	ø7	ø11	ø14			
KLR 1	4081	408101	2,5	50	50	35	8	-	2	-	73 g	20 pcs.	-
KLR 2	4082	408201	2,5	70	70	55	20	-	2	-	157 g	20 pcs.	-
KLR 3	4083	408301	2,5	90	90	65	16	12	2	-	237 g	20 pcs.	-
KLR 4	4084	408401	2,5	100	100	35	16	-	4	-	143 g	20 pcs.	-
KLR 5	4085	408501	2,5	105	105	90	36	-	-	2	381 g	20 pcs.	-
KLR 6	4086	408601	2,5	140	140	55	36	-	4	-	311 g	20 pcs.	-

DX51D + Z275MAC

tested by ITB ↑

NEW

2.06

KLR

Kotwa wzmocniona do betonu • Kotva • Zosilnená kotva do betónu
 Ojačani anker • Erősített bordás lemez • Ancoră întărită pt beton
 Анкер стабилизирующий • Г-образна планка за бетон, усилена • Anclaje reforzado
 Reinforced anchor • Ancrage renforcé pour le béton • Zuganker

KKB

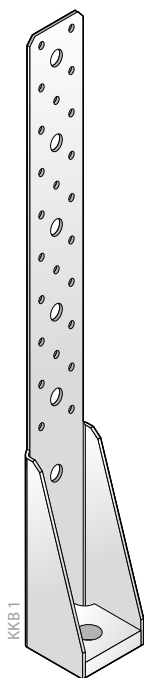
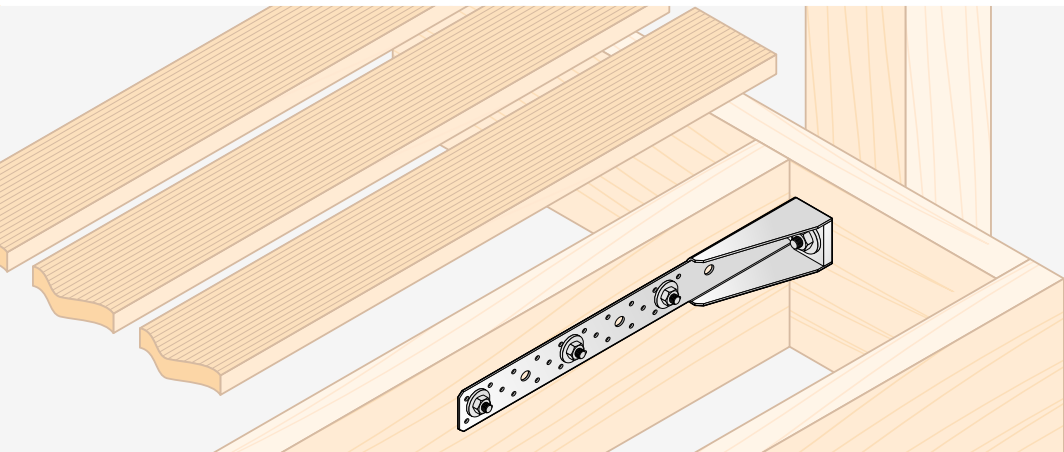

symbol	art. №		≠	[mm]			qty ø			F ↓		
	new	old		a	b	c	ø5	ø11	ø18			
KKB 1	4201	420101	3	400	65	65	24	6	1	876 g	2 pcs.	-

DX51D + Z275MAC

NEW
2.07

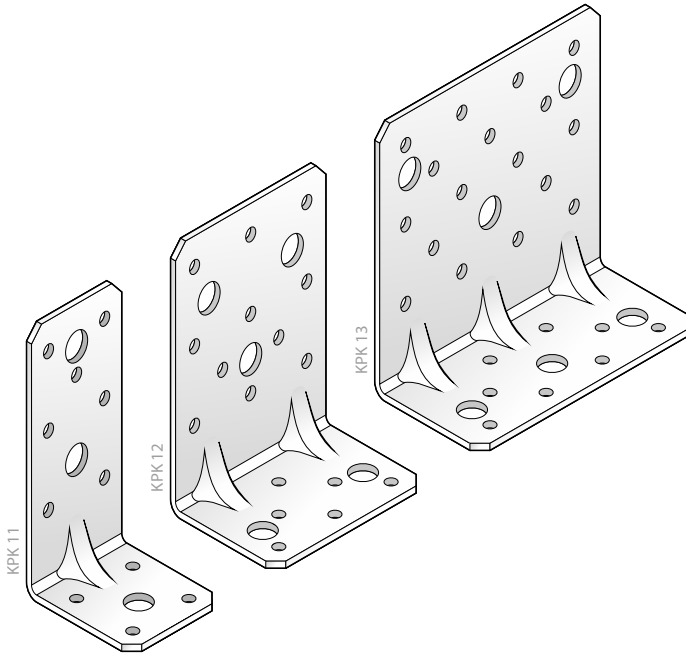

symbol	art. №		≠	[mm]			qty ø		🧴	📦	F↓
	new	old		a	b	c	ø5	ø11			
KPK 11	40411	404111	2,5	95	53	45	11	3	114 g	20 pcs.	-
KPK 12	40412	404121	2,5	95	53	75	17	5	189 g	20 pcs.	-
KPK 13	40413	404131	2,5	95	53	110	25	6	280 g	20 pcs.	-

DX51D + Z275MAC

NEW

2.08

Kątownik z przetłoczeniem • Úhelník s prolisem • Uholník s prelisom
 Montážna spojnica • Sarokösszekötő lemez erősített • Şablon de unghiuri cu suprapresare
 Уголок усиленный • Ъглова планка, оребрена (усилена) • Escuadra reforzada
 Reinforced square • Cornière renforcée • Schwerlast-Winkelverbinder mit Sicke

KPK

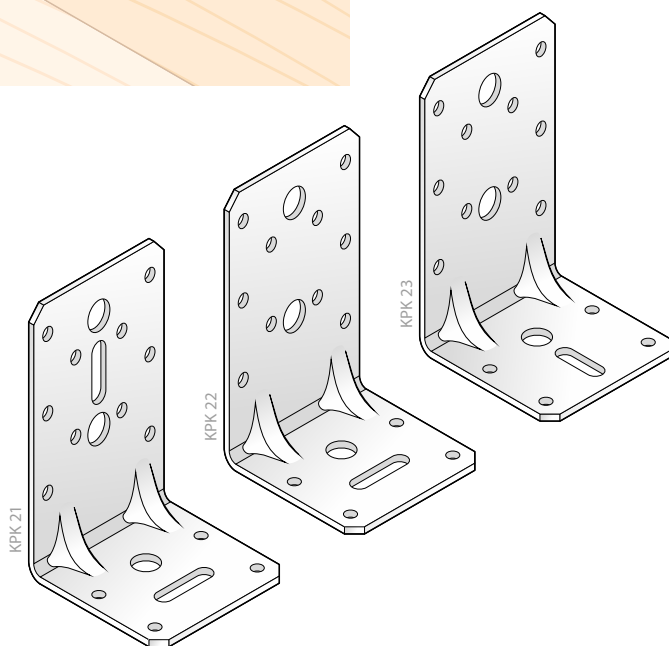
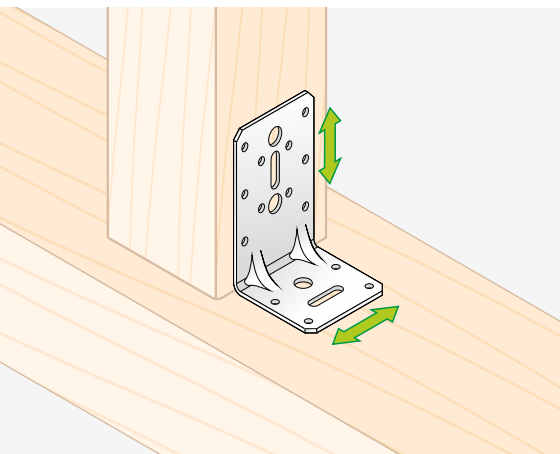



symbol	art. №		[mm]				qty		[mm]				🧴	📦	F↓
	new	old	≠	a	b	c	ø5	ø11	ø5/25	ø7/15	ø7/20	ø11/20			
KPK 21	40421	404211	2,5	95	65	65	14	3	-	1	1	-	177 g	20 pcs.	-
KPK 22	40422	404221	2,5	95	65	65	14	3	-	-	1	-	180 g	20 pcs.	-
KPK 23	40423	404231	2,5	95	65	65	14	3	-	1	-	-	179 g	20 pcs.	-

DX51D + Z275MAC

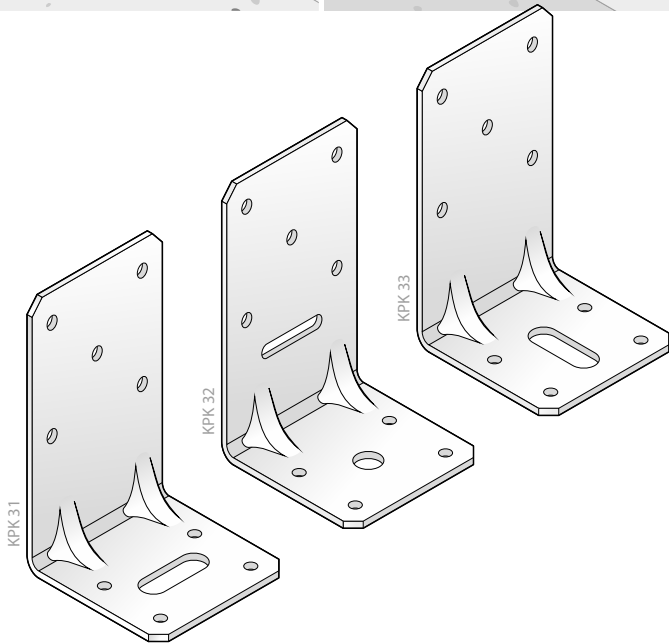
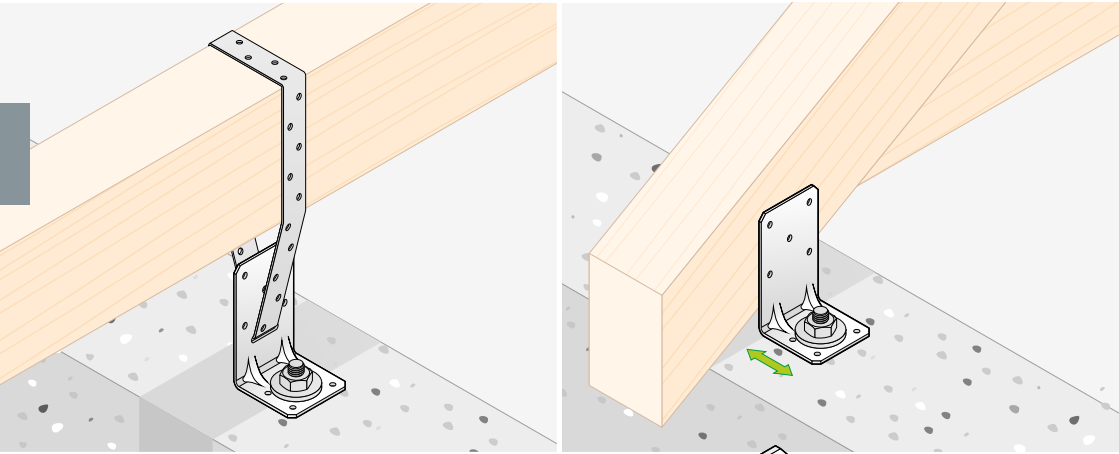
NEW
2.09



symbol	art. №		[mm]				qty		[mm]					F ↓	
	new	old	≠	a	b	c	ø5	ø11	ø5/25	ø7/15	ø7/20	ø11/20			
KPK 31	40431	404311	2,5	95	65	65	9	-	-	-	-	1	185 g	20 pcs.	-
KPK 32	40432	404321	2,5	95	65	65	9	1	1	-	-	-	185 g	20 pcs.	-
KPK 33	40433	404331	2,5	95	65	65	9	-	-	-	-	1	185 g	20 pcs.	-

DX51D + Z275MAC

NEW

2.10

Kątownik z przetłoczeniem • Úhelník s prolisem • Uholník s prelisom
 Montažna spojnica • Sarokösszekötő lemez erősített • Şablon de unghiuri cu suprapresare
 Уголок усиленный • Ъглова планка, оребрена (усиlena) • Escuadra reforzada
 Reinforced square • Cornière renforcée • Schwerlast-Winkelverbinder mit Sicke

KPK

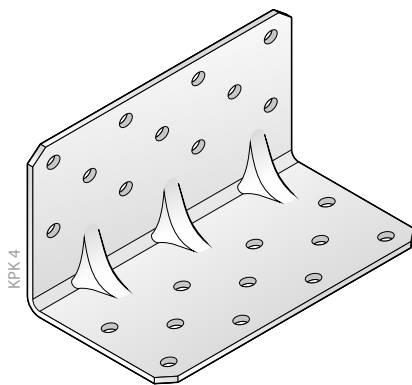
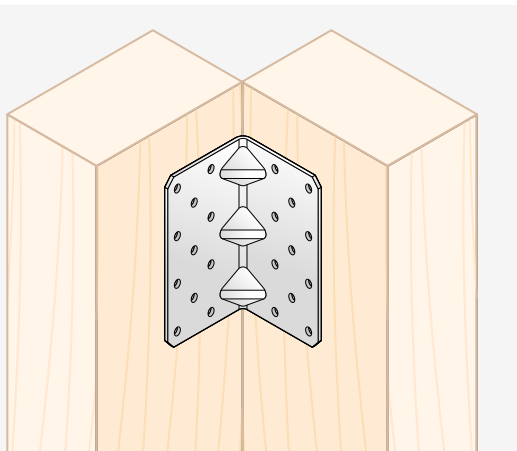

symbol	art. №		±	[mm]			qty ø	📦	F↓
	new	old		a	b	c			
KPK 4	4044	404400	2,5	65	65	100	22 ø5	📦 20 pcs.	-

DX51D + Z275MAC

NEW

2.11

KPK

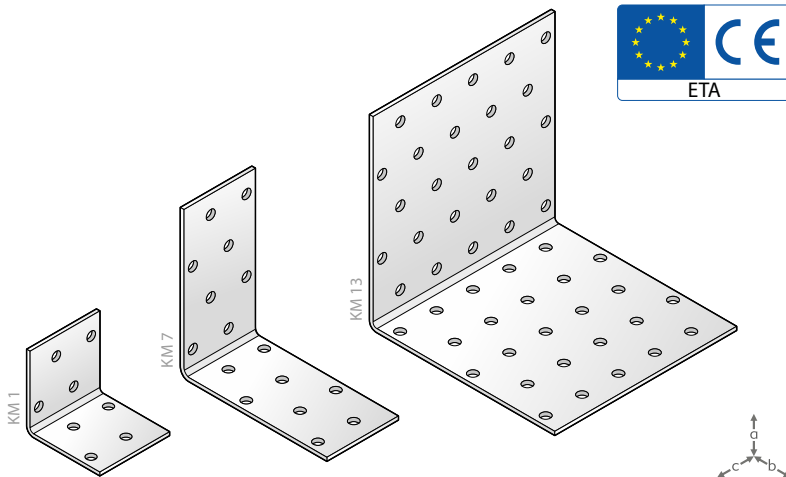

symbol	art. №		[mm]				qty ø	ø5	🧴	📦	F↓
	new	old	±	a	b	c					
KM 1	4101	410101	2	40	40	40	8	47 g	50 pcs.	3,81 kN	
KM 1 /4	410102	428601	2	40	40	40	8	203 g	25 à 4 pcs.	3,81 kN	
KM 1 /12	410105	428701	2	40	40	40	8	579 g	20 à 12 pcs.	3,81 kN	
KM 1 /24	410106	426401	2	40	40	40	8	1116 g	1 à 24 pcs.	3,81 kN	
KM 2	4102	410201	2	40	40	60	12	70 g	50 pcs.	3,81 kN	
KM 2 /12	410205	427501	2	40	40	60	12	840 g	1 à 12 pcs.	3,81 kN	
KM 3	4103	410301	2	60	60	40	12	69 g	20 pcs.	3,83 kN	
KM 3 /4	410302	428801	2	60	60	40	12	315 g	30 à 4 pcs.	3,83 kN	
KM 3 /12	410305	428901	2	60	60	40	12	880 g	25 à 12 pcs.	3,83 kN	
KM 3 /24	410306	426501	2	60	60	40	12	1644 g	1 à 24 pcs.	3,83 kN	
KM 4	4104	410401	2	60	60	60	18	106 g	20 pcs.	5,79 kN	
KM 4 /12	410405	426601	2	60	60	60	18	1274 g	5 à 12 pcs.	5,79 kN	
KM 5	4105	410501	2	60	60	80	24	138 g	20 pcs.	6,86 kN	
KM 6	4106	410601	2	60	60	100	30	177 g	20 pcs.	7,72 kN	
KM 7	4107	410701	2	80	80	40	16	92 g	20 pcs.	5,79 kN	
KM 8	4108	410801	2	80	80	60	24	142 g	20 pcs.	6,68 kN	
KM 9	4109	410901	2	80	80	80	32	189 g	20 pcs.	8,64 kN	
KM 10	4110	411001	2	80	80	100	40	231 g	20 pcs.	10,91 kN	
KM 11	4111	411101	2	100	100	60	30	176 g	20 pcs.	6,99 kN	
KM 12	4112	411201	2	100	100	80	40	237 g	20 pcs.	13,01 kN	
KM 13	4113	411301	2	100	100	100	50	301 g	20 pcs.	13,01 kN	
KM 14	4114	411401	2	40	40	100	20	117 g	20 pcs.	5,65 kN	
KM 15	4115	411501	2	40	40	200	40	230 g	20 pcs.	7,21 kN	
KM 16	4116	411601	2	90	90	40	18	104 g	20 pcs.	-	

DX51D + Z275MAC

tested by ITB ↑

Kątownik montażowy z przetłoczeniem • Uholnik montážny s prelisom • Uholnik montážny s prelisom
 Montažna spojnica, ojačana • Sarokösszekötő lemez perf., erősített • Șablon de unghiuri pt montaj cu suprapresare
 Уголок монтажный усиленный • Монтажна ъглова планка, оребрена (усилена) • Escuadra para montaje, reforzada
 Assembly square, reinforced • Cornière d'assemblage renforcée • Lochplattenwinkel mit Sicke

KMP

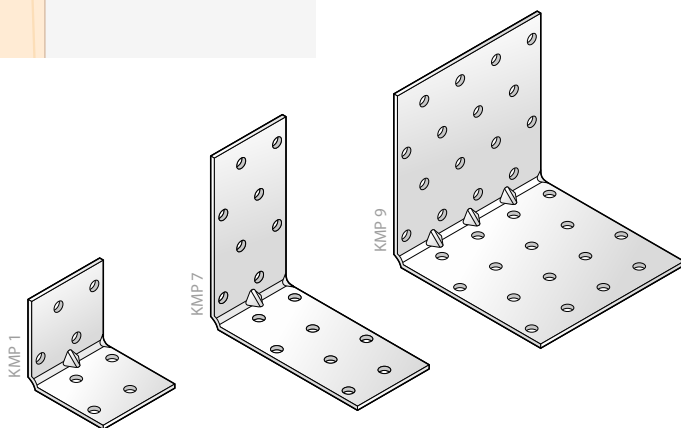
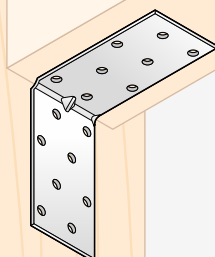

symbol	art. №		[mm]				qty ø	ø5	📦	📦	F↓
	new	old	≠	a	b	c					
KMP 1	4131	413101	1,5	40	40	40	8	47 g	50 pcs.	6,20 kN	
KMP 2	4132	413201	1,5	40	40	60	12	70 g	50 pcs.	7,20 kN	
KMP 3	4133	413301	1,5	40	40	80	12	69 g	50 pcs.	8,20 kN	
KMP 4	4134	413401	1,5	60	60	40	18	106 g	50 pcs.	9,20 kN	
KMP 5	4135	413501	1,5	60	60	60	24	138 g	50 pcs.	10,20 kN	
KMP 6	4136	413601	1,5	60	60	80	30	177 g	50 pcs.	11,20 kN	
KMP 7	4137	413701	1,5	80	80	40	16	92 g	50 pcs.	12,20 kN	
KMP 8	4138	413801	1,5	80	80	60	24	142 g	50 pcs.	13,20 kN	
KMP 9	4139	413901	1,5	80	80	80	32	189 g	50 pcs.	14,20 kN	

DX51D + Z275MAC

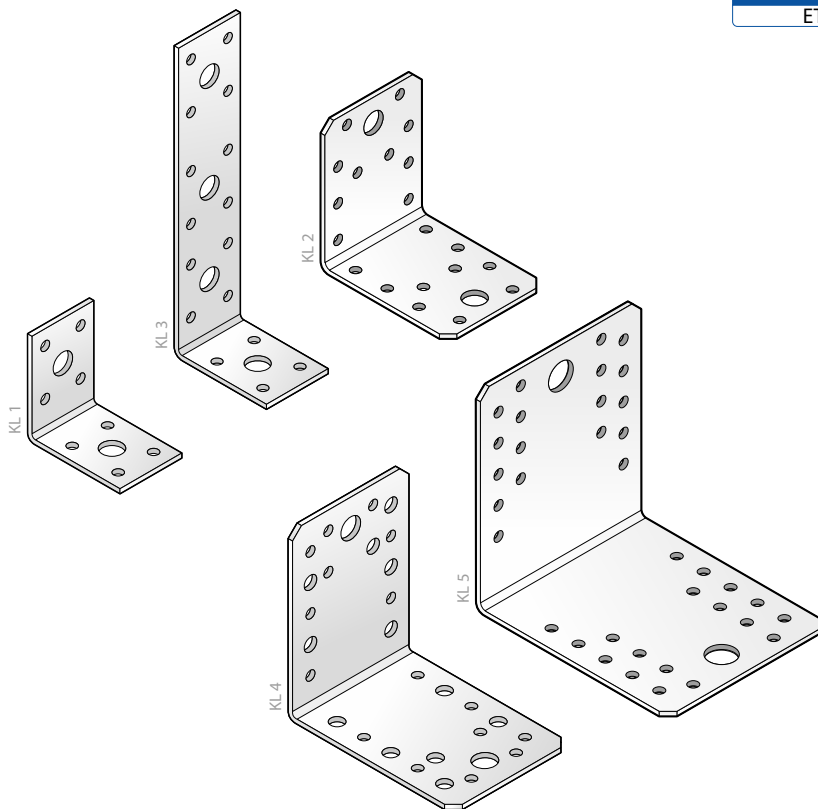

symbol	art. №		[mm]				qty ø				🧴	📦	F↓
	new	old	≠	a	b	c	ø5	ø7	ø11	ø14			
KL 1	4071	403101	2,5	50	50	35	8	-	2	-	61 g	20 pcs.	6,85 kN
KL 1 /24	407106	426201	2,5	50	50	35	8	-	2	-	1459 g	1 à 24 pcs.	6,85 kN
KL 2	4072	403201	2,5	70	70	55	20	-	2	-	137 g	20 pcs.	10,95 kN
KL 2 /12	407205	426301	2,5	70	70	55	20	-	2	-	1646 g	1 à 12 pcs.	10,95 kN
KL 3	4073	403301	2,5	150	50	35	16	-	4	-	118 g	20 pcs.	14,90 kN
KL 4	4074	403401	2,5	90	90	65	16	12	2	-	209 g	20 pcs.	17,80 kN
KL 5	4075	403501	2,5	105	105	90	36	-	-	2	347 g	20 pcs.	21,90 kN



DX51D + Z275MAC

tested by ITB ↑

Kařtownik kotwowy • Úhelník kotevní • Uholník kotevný
 Anker spojnica • Beton-acéllemez összekötő • Şablon de unhiuri de ancoră
 Анкерный уголок • Г-образна планка • Escudra para anclar
 Anchor square • Cornière d'ancrage • Flachstahlanker zum Einbetonieren

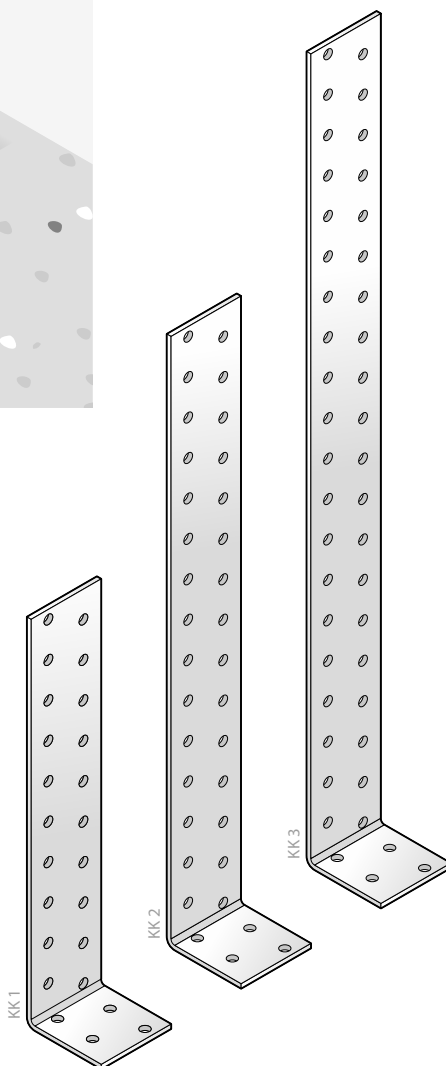
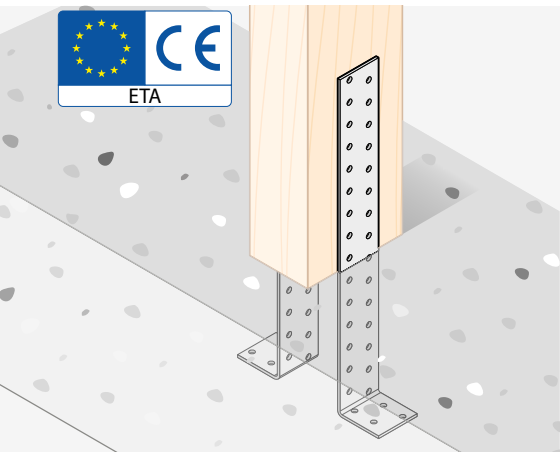
KK



symbol	art. №		[mm]				qty ø			F↓
	new	old	≠	a	b	c				
KK 1	4151	412101	2,0	200	40	40	24	140 g	20 pcs.	8,90 kN
KK 2	4152	412201	2,0	300	40	40	34	196 g	20 pcs.	11,52 kN
KK 3	4153	412301	2,0	400	40	40	44	249 g	20 pcs.	14,26 kN

DX51D + Z275MAC

tested by ITB ↑

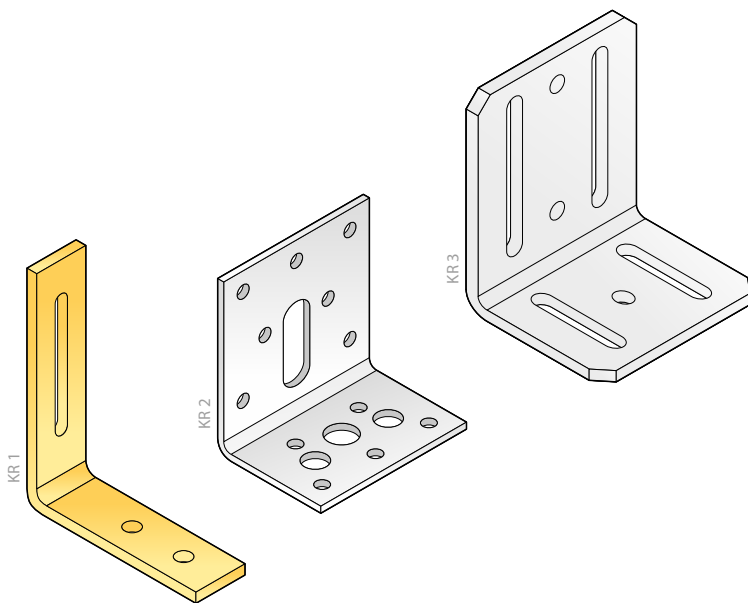
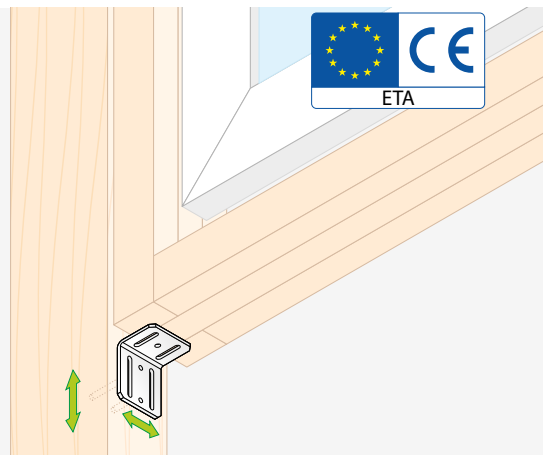
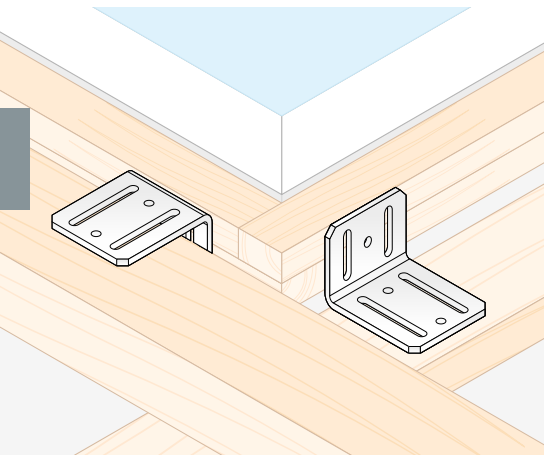

symbol	art. №		[mm]				qty ø				[mm]				🧴	📦	F↓
	new	old	±	a	b	c	ø5	ø6	ø9	ø11	ø5/6	ø11/9	ø6.5/2.5	ø6.5/9			
KR 1	4211	421101	3,0	80	60	20	-	2	-	-	1	-	-	-	57 g	20 pcs.	-
KR 2	4212	421201	2,5	60	40	60	12	-	2	1	-	1	-	101 g	20 pcs.	3,74 kN	
NEW KR 3	4213	421301	4,0	75	45	65	-	3	-	-	-	-	2	192 g	20 pcs.	-	

KR1: DC01 electrogalvanized
 KR 2,3: DX51D + Z275MAC

tested by ITB ↑

Kątownik z regulacją • Úhelník staviteľný • Uholník nastaviteľný
 Podesiva ugaona spojnica • Szegletvas állítható • Şablon de unghiuri cu reglare
 Уголок регулируемый • Ёглов планка, регулируема • Escuadra ajustable
 Adjustable square • Cornière réglable • Verstellwinkel

KMR

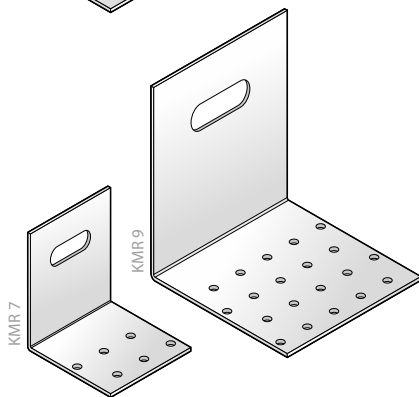
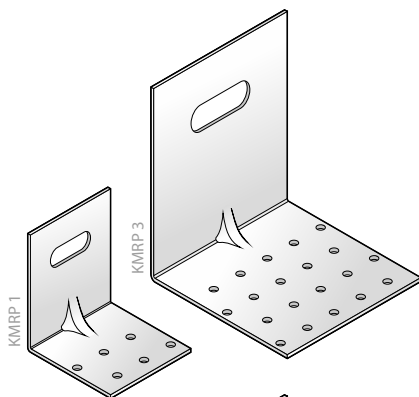
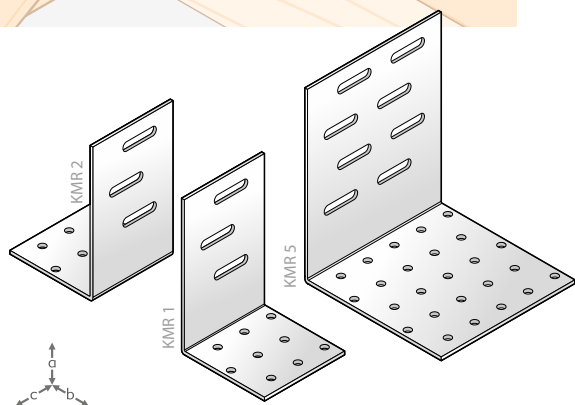
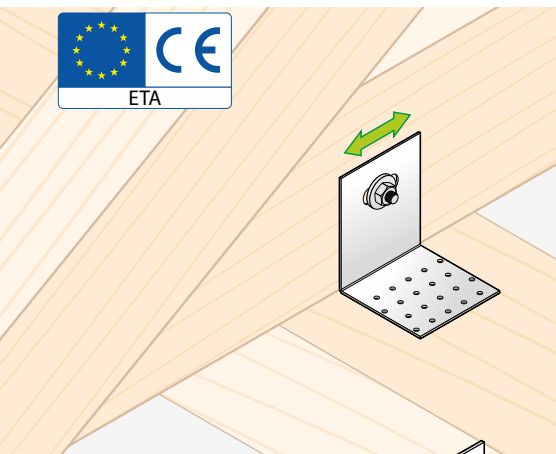



symbol	art. №		[mm]			qty	ø	[mm]			🧴	📦	F ↓
	new	old	≠	a	b			c	ø1/20	ø10/20			
KMR 1	4231	423101	2,0	80	60	60	9	3	-	-	130 g	20 pcs.	5,52 kN
KMR 2	4232	423201	2,0	80	60	60	9	3	-	-	130 g	20 pcs.	5,52 kN
KMR 3	4233	423301	2,0	80	80	80	16	4	-	-	200 g	20 pcs.	8,65 kN
KMR 4	4234	423401	2,0	80	80	80	16	4	-	-	200 g	20 pcs.	8,65 kN
KMR 5	4235	423501	2,0	100	100	100	23	8	-	-	320 g	20 pcs.	10,92 kN
KMR 6	4236	423601	2,0	100	100	100	23	8	-	-	320 g	20 pcs.	10,92 kN
KMR 7	4237	424101	2,0	60	60	60	8	-	1	-	110 g	20 pcs.	3,70 kN
KMR 8	4238	424201	2,0	80	80	80	12	-	1	-	200 g	20 pcs.	6,73 kN
KMR 9	4239	424301	2,0	100	100	100	20	-	-	1	320 g	20 pcs.	6,63 kN
KMRP 1	4241	424601	2,0	60	60	60	6	-	1	-	110 g	20 pcs.	3,74 kN
KMRP 2	4242	424701	2,0	80	80	80	12	-	1	-	200 g	20 pcs.	6,90 kN
KMRP 3	4243	424801	2,0	100	100	100	20	-	-	1	320 g	20 pcs.	7,40 kN

DX51D + Z275MAC

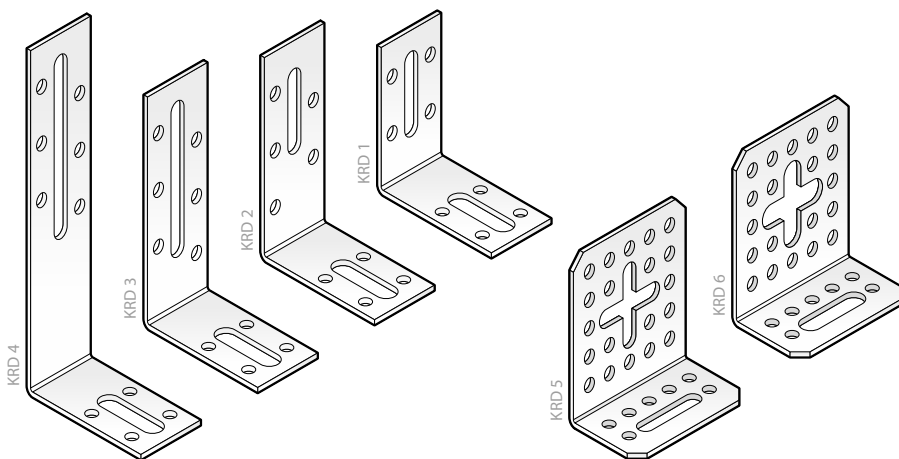
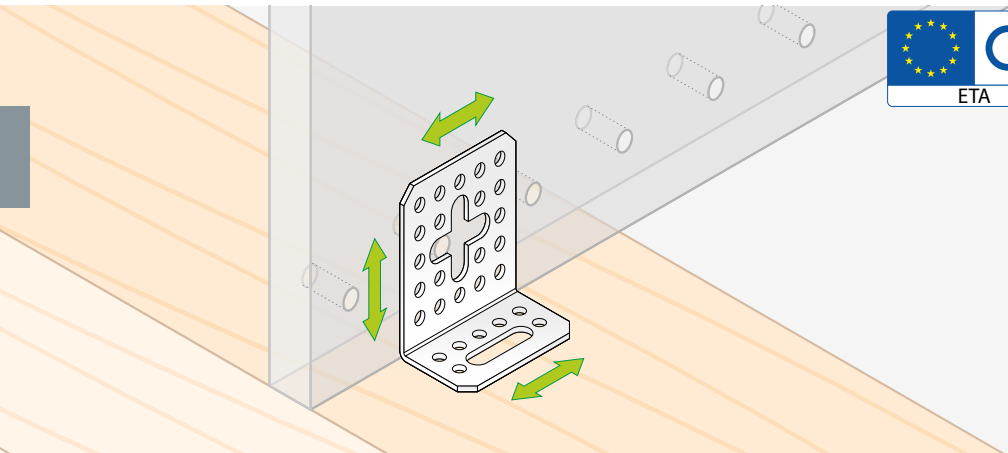
tested by ITB ↑



symbol	art. №		[mm]			qty \emptyset	[mm]						F \downarrow	
	new	old	\neq	a	b		c	$\emptyset 5$	$\emptyset 5/23,5$	$\emptyset 5/48,5$				$\emptyset 5/88,5$
KRD 1	4215	421501	2,0	50	55	30	8	1	-	-	1	40 g	20 pcs.	-
KRD 2	4216	421601	2,0	70	55	30	9	1	-	-	1	45 g	20 pcs.	6,68 kN
KRD 3	4217	421701	2,0	80	55	30	10	-	1	-	1	51 g	20 pcs.	6,75 kN
KRD 4	4218	421801	2,0	120	55	30	10	-	-	1	1	67 g	20 pcs.	6,75 kN
KRD 5	4219	421901	2,0	60	34	56	27	3	-	-	-	60 g	20 pcs.	-
KRD 6	4220	422001	2,0	60	34	56	27	-	-	-	3	58 g	20 pcs.	-

DX51D + Z275MAC

tested by ITB \uparrow

Łącznik do betonu • Spojka do betonu • Spojka do betónu
 Konektor za beton • Szegletvas állítható betonhoz • Racord pt beton
 Уголок для бетона • Стъпка за бетон • Conector para hormigón
 Concrete connector • Joint pour le béton • Betonwinkel

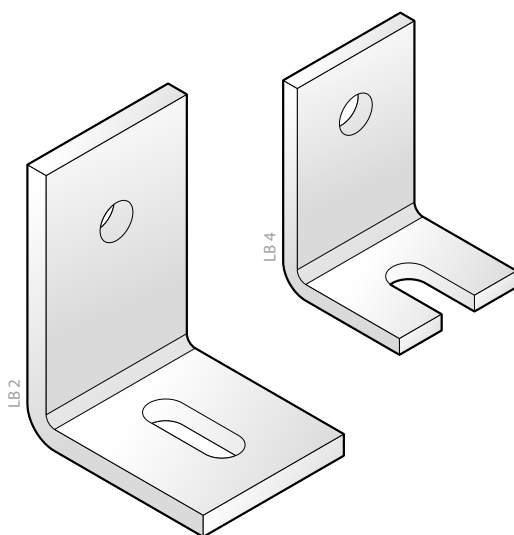
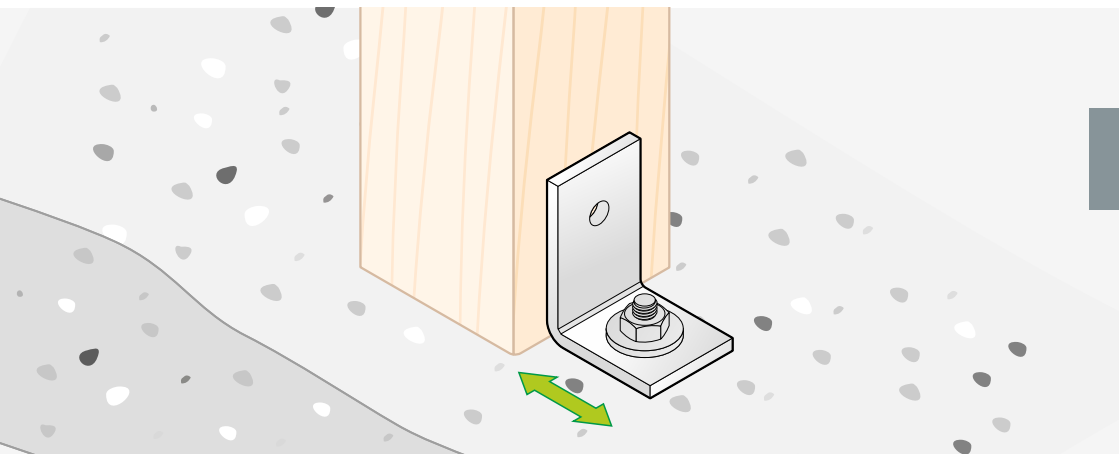

LB

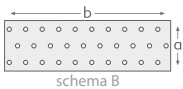
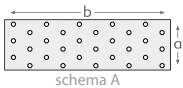
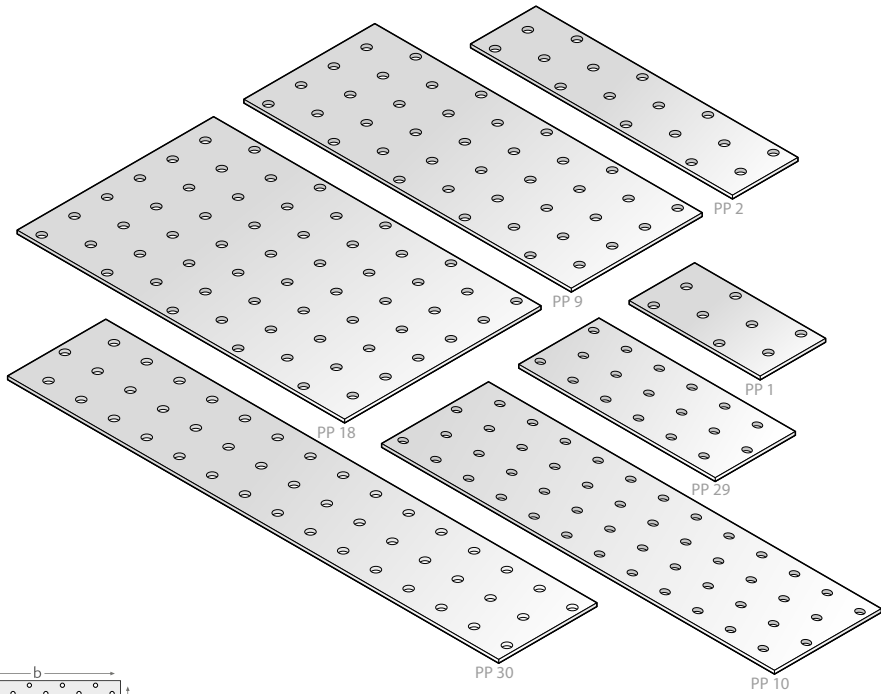

symbol	art. №		[mm]				qty ø	ø6,5/50	📦	📦	F↓
	new	old	≠	a	b	c					
LB 1	4221	422101	6,0	75	75	50	1	1	305 g	10 pcs.	-
LB 2	4222	422201	8,0	100	75	60	1	1	563 g	10 pcs.	-
LB 4	4224	422401	6,0	75	50	50	1	1	245 g	10 pcs.	-

S235 electrogalvanized





symbol	art. №		[mm]			schema	qty ø5			F↓
	new	old	≠	a	b					
PP1	4401	440101	2,0	40	80	A	8	47 g	20 pcs.	3,47 kN
PP1 /4	440102	429001	2,0	40	80	A	8	208 g	20 pcs.	3,47 kN
PP1 /12	440105	429101	2,0	40	80	A	8	591 g	15 pcs.	3,47 kN
PP2	4402	440201	2,0	40	100	A	10	58 g	20 pcs.	3,51 kN
PP3	4403	440301	2,0	40	120	A	12	71 g	20 pcs.	3,42 kN
PP3 /4	440302	429201	2,0	40	120	A	12	309 g	10 pcs.	3,42 kN
PP3 /12	440305	429301	2,0	40	120	A	12	927 g	8 pcs.	3,42 kN

DX51D + Z275MAC

tested by ITB ↑

Płytki perforowane • Destycká perforovaná • Doštička perforovaná
 Anker ploča • Összekötő lemez • Plăcuță perforată
 Монтажная пластина • Перфорирани планка • Placa perforada
 Anchor plate • Plaque perforée • Lochplatte

PP

symbol	art. №		[mm]			schema	qty ø			F ↓
	new	old	≠	a	b					
PP4	4404	440401	2,0	40	160	A	16	101 g	20 pcs.	3,48 kN
PP5	4405	440501	2,0	60	140	A	21	124 g	20 pcs.	3,54 kN
PP6	4406	440601	2,0	60	160	A	24	149 g	20 pcs.	3,70 kN
PP7	4407	440701	2,0	60	200	A	30	181 g	20 pcs.	3,75 kN
PP7 /4	440702	426701	2,0	60	200	A	30	724 g	1 pcs.	3,75 kN
PP7 /12	440705	426801	2,0	60	200	A	30	2172 g	1 pcs.	3,75 kN
PP8	4408	440801	2,0	60	240	B	36	214 g	20 pcs.	3,76 kN
PP9	4409	440901	2,0	80	200	A	40	236 g	20 pcs.	4,39 kN
PP10	4410	441001	2,0	80	240	B	48	283 g	20 pcs.	4,39 kN
PP11	4411	441101	2,0	80	300	B	60	372 g	10 pcs.	5,03 kN
PP12	4412	441201	2,0	100	200	B	50	306 g	10 pcs.	4,32 kN
PP13	4413	441301	2,0	100	240	B	60	368 g	10 pcs.	4,94 kN
PP14	4414	441401	2,0	100	260	B	65	380 g	10 pcs.	-
PP15	4415	441501	2,0	100	300	B	75	440 g	10 pcs.	-
PP16	4416	441601	2,0	100	400	B	100	586 g	10 pcs.	-
PP17	4417	441701	2,0	100	500	B	125	732 g	10 pcs.	-
PP18	4418	441801	2,0	120	200	A	60	350 g	10 pcs.	-
PP19	4419	441901	2,0	120	240	B	72	428 g	10 pcs.	-
PP20	4420	442001	2,0	120	260	B	78	464 g	10 pcs.	-
PP21	4421	442101	2,0	120	300	B	90	532 g	10 pcs.	-
PP22	4422	442201	2,0	140	400	B	140	827 g	10 pcs.	-
PP23	4423	442301	2,0	160	400	B	160	978 g	10 pcs.	-
PP24	4424	442401	2,0	200	300	B	150	878 g	10 pcs.	-
PP25	4425	438401	2,0	200	400	B	200	1152 g	20 pcs.	-
PP26	4426	430981	2,0	200	500	B	250	1470 g	1 pcs.	- NEW
PP27	4427	442701	2,0	200	600	B	300	1770 g	10 pcs.	-
PP28	4428	438001	2,0	40	200	B	20	117 g	20 pcs.	-
PP29	4429	438101	2,0	60	120	A	18	107 g	20 pcs.	-
PP30	4430	438201	2,0	60	300	B	45	262 g	20 pcs.	-
PP31	4431	438301	2,0	100	120	A	30	176 g	20 pcs.	-
PP33	4433	430251	2,0	80	120	A	24	138 g	1 pcs.	- NEW
PP35	4435	430381	2,0	100	100	A	25	144 g	1 pcs.	- NEW
PP91	4391	442501	2,0	40	1200	B	120	691 g	10 pcs.	-
PP92	4392	442601	2,0	60	1200	B	180	1037 g	10 pcs.	-
PP93	4393	430291	2,0	80	1200	B	240	1382 g	1 pcs.	- NEW
PP94	4394	430391	2,0	100	1200	B	300	1728 g	1 pcs.	- NEW
PP95	4395	430491	2,0	120	1200	B	360	2074 g	1 pcs.	- NEW
PP96	4396	430591	2,0	140	1200	B	420	2419 g	1 pcs.	- NEW
PP97	4397	430691	2,0	160	1200	B	480	2765 g	1 pcs.	- NEW
PP98	4398	430891	2,0	180	1200	B	540	3110 g	1 pcs.	- NEW
PP99	4399	430991	2,0	200	1200	B	600	3456 g	1 pcs.	- NEW

DX51D + Z275MAC

tested by ITB ↑

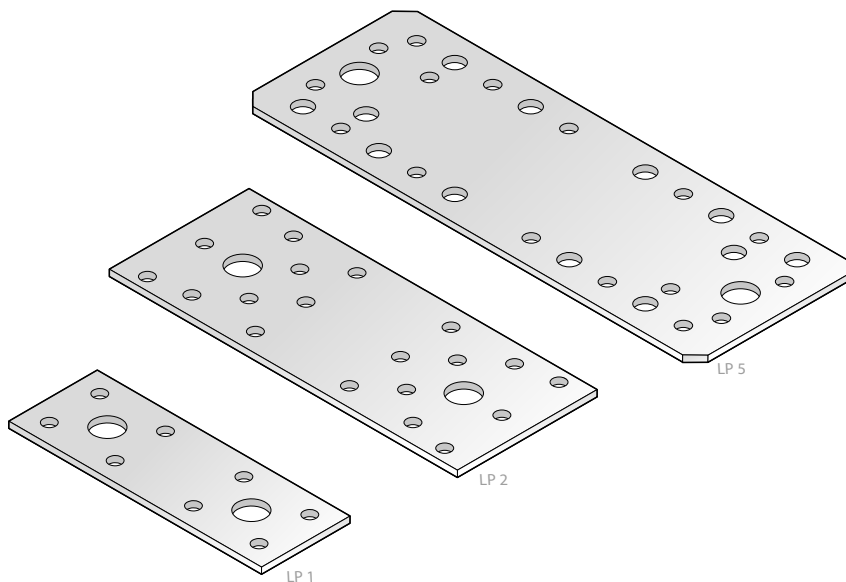

symbol	art. №		[mm]			qty ø				🧴	📦	F↓
	new	old	±	a	b	ø5	ø7	ø11	ø14			
LP 1	4471	444101	2,5	100	35	8	-	2	-	61 g	20 pcs.	3,51 kN
LP 1 /24	447106	426901	2,5	100	35	8	-	2	-	1464 g	1 à 24 pcs.	3,51 kN
LP 2	4472	444201	2,5	140	55	20	-	2	-	136 g	20 pcs.	3,70 kN
LP 3	4473	444301	2,5	200	35	16	-	4	-	117 g	20 pcs.	3,60 kN
LP 4	4474	444401	2,5	280	55	40	-	4	-	270 g	20 pcs.	3,67 kN
LP 5	4475	444501	2,5	180	65	16	12	2	-	209 g	20 pcs.	3,51 kN
LP 6	4476	444601	2,5	210	90	36	-	-	2	347 g	20 pcs.	3,75 kN



DX51D + Z275MAC

tested by ITB ↑

Łącznik wąski • Spojka úzká • Spojka úzka
 Uzana spojnica • Keskeny összekötő lemez • Racord îngust
 Крепление узкое • Тясна връзка • Conector estrecho
 Narrow connector • Joint étroit • Flachverbinder

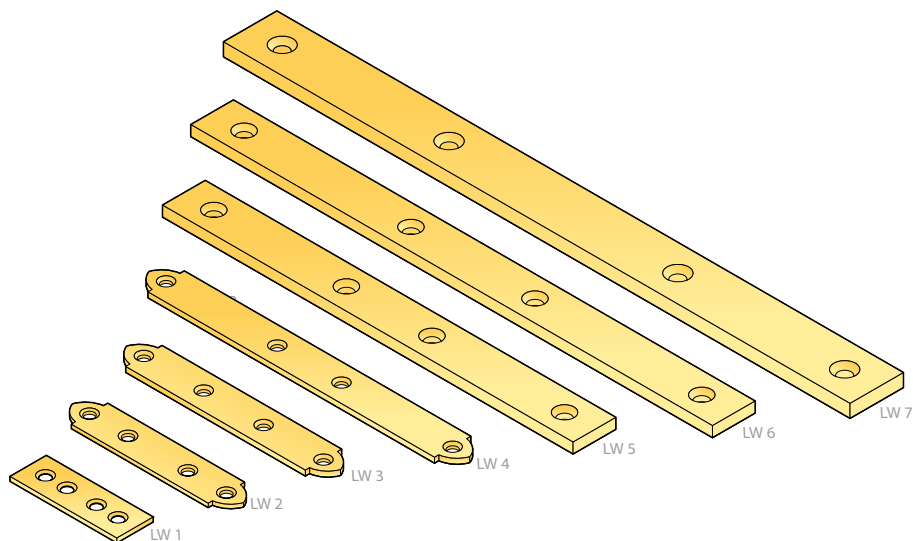
LW





symbol	art. №		[mm]			qty ø				F↓
	new	old	≠	a	b	ø5	ø6			
LW 1	4451	445101	1,5	48	17	4	-	12 g	50 pcs.	3,38 kN
LW 1 /12	445105	427301	1,5	48	17	4	-	148 g	40 à 12 pcs.	3,38 kN
LW 2	4452	445201	1,5	78	17	4	-	18 g	50 pcs.	3,38 kN
LW 2 /8	445204	427401	1,5	78	17	4	-	146 g	20 à 8 pcs.	3,38 kN
LW 3	4453	445301	2,0	98	17	4	-	23 g	50 pcs.	3,38 kN
LW 4	4454	445401	2,0	148	17	4	-	38 g	50 pcs.	3,38 kN
LW 5	4455	445501	4,0	193	20	-	4	112 g	20 pcs.	3,38 kN
LW 6	4456	445601	4,0	243	20	-	4	154 g	20 pcs.	3,38 kN
LW 7	4457	445701	5,0	293	25	-	4	290 g	20 pcs.	3,38 kN

LW 1-4: DC01 electrogalvanized
 LW 5-7: S235 electrogalvanized

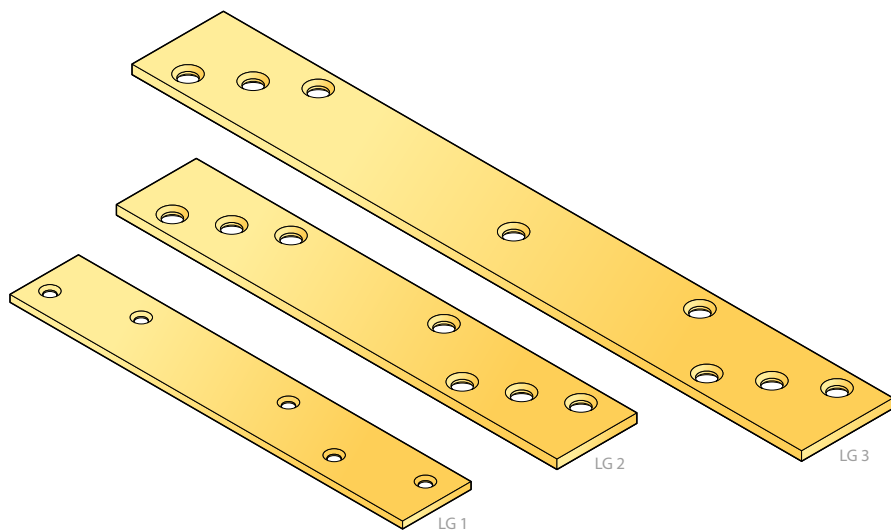
tested by ITB ↑



symbol	art. №		[mm]			qty ø				F↓
	new	old	≠	a	b	ø4,5	ø7			
LG 1	4461	446101	3,0	172	30	5	-	120 g	20 pcs.	3,48 kN
LG 2	4462	446201	4,0	193	35	-	7	196 g	20 pcs.	3,72 kN
LG 3	4463	446301	5,0	293	40	-	8	448 g	20 pcs.	3,72 kN

LG 1: DC01 electrogalvanized
 LG 2,3: S235 electrogalvanized

tested by ITB ↑

Łącznik typu T • Spojka typu T • Spojka typu T
 T-tip konektor • Szegletvas T • Racord tip T
 Крепление тип T • Връзка T-образна • Conector tipo T
 T-type connector • Joint de type T • Flachverbinder T-Form

KT

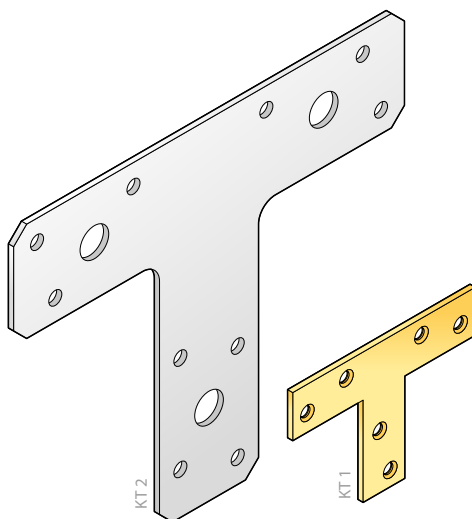
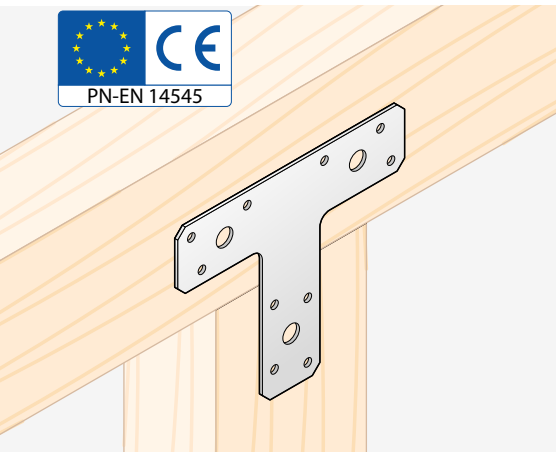

symbol	art. №		[mm]				qty ø					F ↓
	new	old	±	a	b	c	ø4	ø5	ø11			
KT 1	4626	462601	2,0	70	50	16	6	-	-	26 g	50 pcs.	3,35 kN
KT 2	4627	462701	2,0	150	127	38	-	10	3	132 g	20 pcs.	3,45 kN

KT 1: DC01 electrogalvanized
 KT 2: DX51D + Z272MAC

tested by ITB ↑

2.25

KT

Napínací tašmy, komplet ze šroubami • Napínač montážní pásky, komplet vč. Šroubů • Napínač montážnej pásky ,komplet vr. Šróbov
 Zatezni kaiš, set sa šrafovim • Övfeszítő csavarral • Întinzător de bandă, set cu șuruburi
 Натяжитель ленты, комплект • Обтегач за монтажна лента, комплект с винтове • Tensor de correa, set con tornillos
 Belt tensioner, set with screws • Tendeur de bande, jeu avec vis • Windverbandanschluss

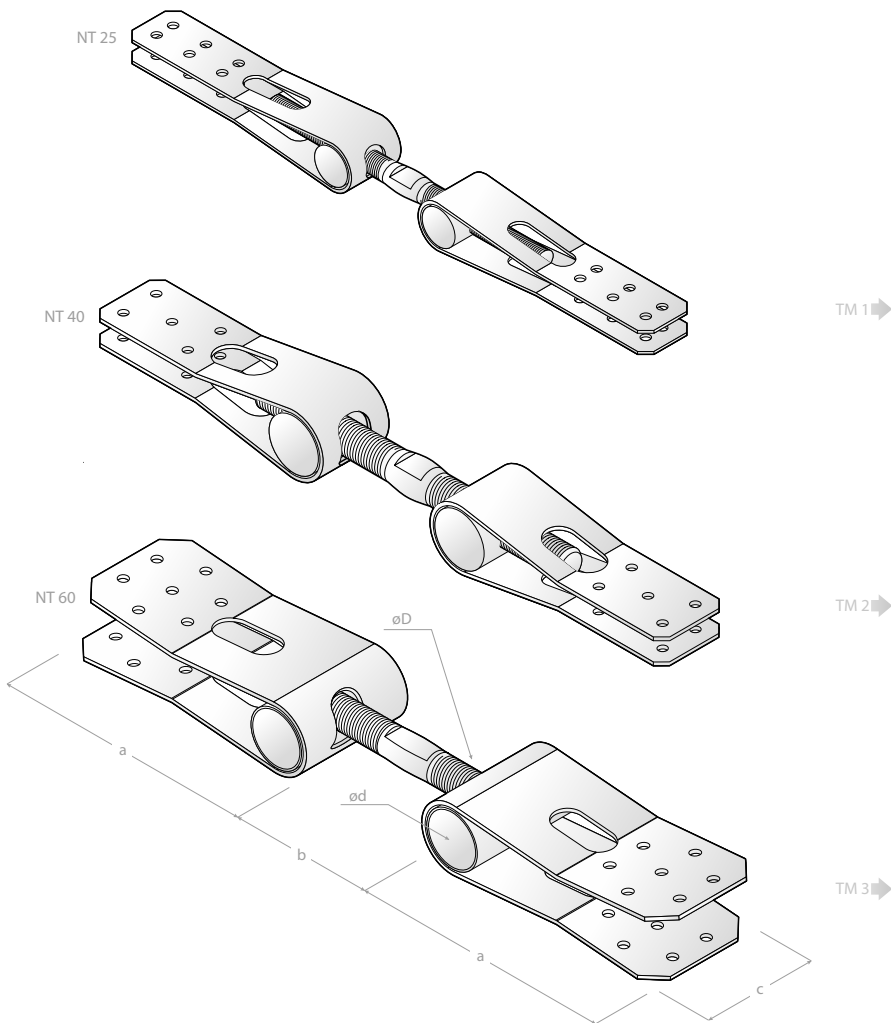

symbol	art. №		≠	[mm]					D	qty ø	ø5	📦	F↓
	new	old		a	b	c	d						
NT 25	4351	442801	2,0	135	15-120	25	20	M10	12	480 g	1 pcs.	21,5 kN	
NT 40	4352	442901	2,0	140	15-120	40	30	M16	10	901 g	1 pcs.	37,4 kN	
NT 60	4353	443001	2,0	140	15-120	60	30	M16	14	1300 g	1 pcs.	-	

DX51D + Z275MAC

tested by Domax Lab. ↑

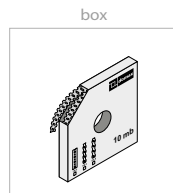
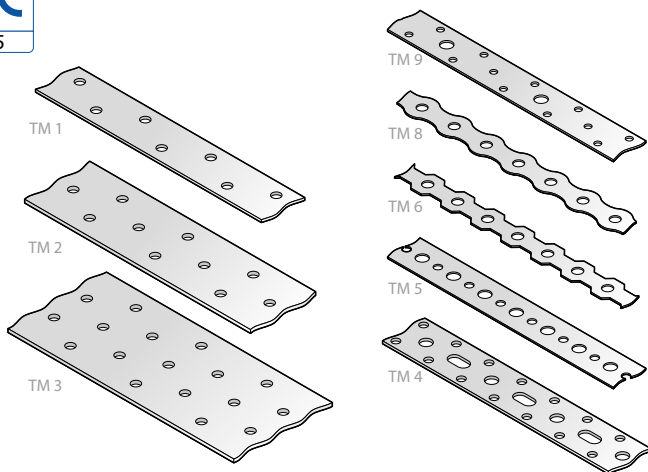

symbol	art. №		[mm]			qty ø/m [mm]				ø6/6	🧴	📦	F ↓
	new	old	≠	a	b	ø4	ø5	ø6	ø7				
TM 1 x 10mb	43311	443111	1,5	10 m	25	-	50	-	-	-	281 g	10 pcs.	3,46 kN
TM 1 x 25mb	43312	443101	1,5	25 m	25	-	50	-	-	-	281 g	25 pcs.	3,46 kN
TM 1 x 50mb	43315	443151	1,5	50 m	25	-	50	-	-	-	281 g	50 pcs.	3,46 kN
TM 2 x 10mb	43321	443211	2,0	10 m	40	-	75	-	-	-	600 g	10 pcs.	3,75 kN
TM 2 x 25mb	43322	443201	2,0	25 m	40	-	75	-	-	-	600 g	25 pcs.	3,75 kN
TM 2 x 50mb	43325	443251	2,0	50 m	40	-	75	-	-	-	600 g	50 pcs.	3,75 kN
TM 3 x 10mb	43331	443311	2,0	10 m	60	-	125	-	-	-	960 g	10 pcs.	6,84 kN
TM 3 x 25mb	43332	443301	2,0	25 m	60	-	125	-	-	-	908 g	25 pcs.	6,84 kN
TM 3 x 50mb	43335	443351	2,0	5 m	60	-	125	-	-	-	960 g	50 pcs.	6,84 kN
TM 4 x 10mb	43341	443411	1,5	10 m	25	100	-	25	-	25	249 g	10 pcs.	-
TM 4 x 25mb	43342	443401	1,5	25 m	25	100	-	25	-	25	249 g	25 pcs.	-
TM 4 x 50mb	43345	443451	1,5	50 m	25	100	-	25	-	25	249 g	50 pcs.	-
TM 5 x 10mb	43351	443511	0,8	10 m	20	50	-	50	-	-	114 g	10 pcs.	-
TM 5 x 25mb	43352	443501	0,8	25 m	20	50	-	50	-	-	114 g	25 pcs.	-
TM 5 /3mb	43353	443531	0,8	3 m	20	50	-	50	-	-	341 g	10 pcs.	-
TM 6 x 10mb	43361	443611	0,8	10 m	15	-	-	50	-	-	77 g	10 pcs.	-
TM 6 x 25mb	43362	443601	0,8	25 m	15	-	-	50	-	-	77 g	25 pcs.	-
TM 6 /3mb	43363	443631	0,8	3 m	15	-	-	50	-	-	230 g	10 pcs.	-
TM 8 x 10mb	43381	443811	0,8	10 m	15	-	-	50	-	-	77 g	10 pcs.	-
TM 8 x 25mb	43382	443801	0,8	25 m	15	-	-	50	-	-	77 g	25 pcs.	-
TM 8 /3mb	43383	443831	0,8	3 m	15	-	-	50	-	-	230 g	10 pcs.	-
TM 9 x 10mb	43391	443911	1,0	10 m	20	100	-	-	20	-	130 g	10 pcs.	-
TM 9 x 25mb	43392	443921	1,0	25 m	20	100	-	-	20	-	130 g	25 pcs.	-

DX51D + Z275MAC

tested by ITB ↑

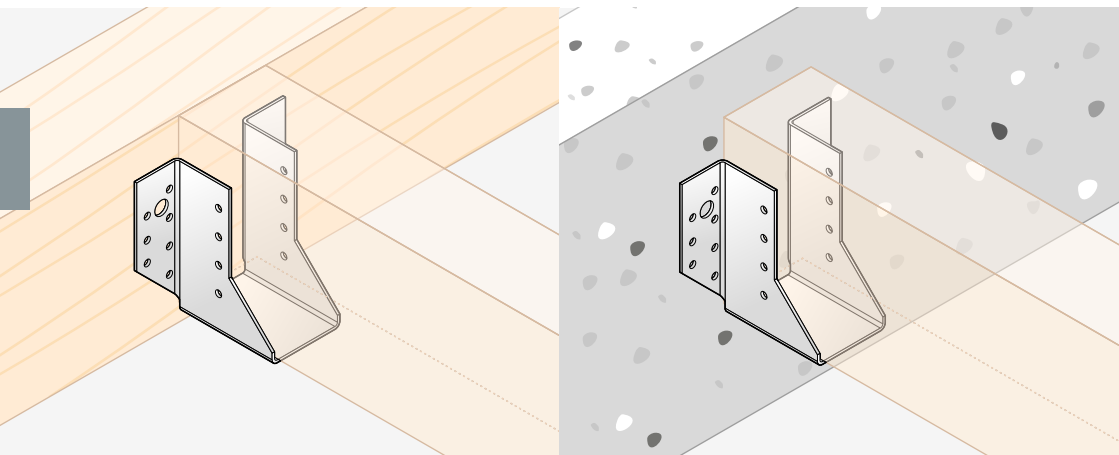

symbol	art. №		[mm]				qty ø		🧴	📦	F↓
	new	old	≠	a	b	c	ø5	ø11			
WBD 105L	4543	-	2,0	25	105	75	13	1	145 g	10 pcs.	26,96 kN
WBD 105P	4544	-	2,0	25	105	75	13	1	145 g	10 pcs.	26,96 kN
WBD 130L	4551	455101	2,0	28	130	75	16	2	180 g	10 pcs.	26,96 kN
WBD 130P	4552	455201	2,0	28	130	75	16	2	180 g	10 pcs.	26,96 kN
WBD 140L	4545	-	2,0	50	140	75	19	2	215 g	10 pcs.	26,96 kN
WBD 140P	4546	-	2,0	50	140	75	19	2	215 g	10 pcs.	26,96 kN
WBD 170L	4547	-	2,0	50	170	75	22	3	245 g	10 pcs.	26,96 kN
WBD 170P	4548	-	2,0	50	170	75	22	3	245 g	10 pcs.	26,96 kN
WBD 200L	4549	-	2,0	50	200	75	25	3	280 g	10 pcs.	26,96 kN
WBD 200P	4550	-	2,0	50	200	75	25	3	280 g	10 pcs.	26,96 kN
WB 1	4501	450101	2,0	25	118	75	22	2	297 g	10 pcs.	17,05 kN
WB 2	4502	450201	2,0	38	111	75	22	2	297 g	10 pcs.	17,05 kN
WB 3	4503	450301	2,0	38	141	75	28	4	363 g	10 pcs.	20,30 kN
WB 4	4504	450401	2,0	38	171	75	34	4	440 g	10 pcs.	25,45 kN
WB 5	4505	450501	2,0	41	110	75	22	2	297 g	10 pcs.	17,05 kN
WB 6	4506	450601	2,0	41	140	75	28	4	363 g	10 pcs.	20,30 kN
WB 7	4507	450701	2,0	41	170	75	34	4	440 g	10 pcs.	25,45 kN
WB 8	4508	450801	2,0	45	108	75	22	2	297 g	10 pcs.	17,05 kN
WB 9	4509	450901	2,0	45	138	75	28	4	363 g	10 pcs.	20,30 kN
WB 10	4510	451001	2,0	51	105	75	22	2	297 g	10 pcs.	17,05 kN
WB 11	4511	451101	2,0	51	135	75	28	4	363 g	10 pcs.	20,30 kN
WB 12	4512	451201	2,0	51	165	75	34	4	440 g	10 pcs.	25,45 kN
WB 13	4513	451301	2,0	51	195	75	40	6	485 g	10 pcs.	27,75 kN
WB 14	4514	451401	2,0	60	100	75	22	2	297 g	10 pcs.	17,05 kN
WB 14 /6	451403	427001	2,0	60	100	75	22	2	1784 g	1 à 6 pcs.	17,05 kN

DX51D + Z275MAC

tested by ITB ↑

Wieszak belki • Trámová botka • Trámová papuča
 Nosač grede • Gerenda szeglemez • Dispozitiv de agățare pt grindă
 Крепление балки • Пета за греда • Soporte fijación alas exteriores
 Joist hanger • Suspente de solive • Balkenschuh

WB

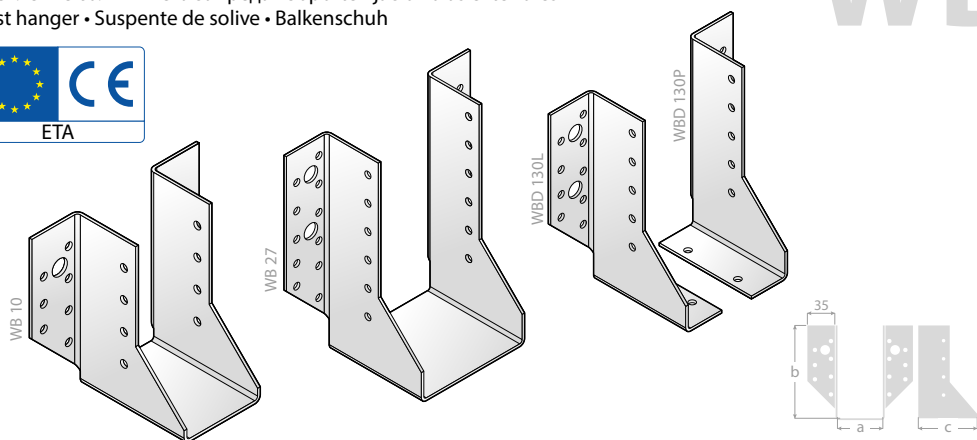

symbol	art. №		[mm]			qty \emptyset		🧴	📦	F ↓	
	new	old	±	a	b	c	$\emptyset 5$				$\emptyset 11$
WB 15	4515	451501	2,0	60	130	75	28	4	363 g	10 pcs.	20,30 kN
WB 16	4516	451601	2,0	60	160	75	34	4	440 g	10 pcs.	25,45 kN
WB 17	4517	451701	2,0	60	190	75	40	6	485 g	10 pcs.	27,75 kN
WB 18	4518	451801	2,0	60	220	75	46	6	555 g	10 pcs.	32,30 kN
WB 19	4519	451901	2,0	64	98	75	22	2	297 g	10 pcs.	17,05 kN
WB 20	4520	452001	2,0	64	128	75	28	4	363 g	10 pcs.	20,30 kN
WB 21	4521	452101	2,0	70	125	75	28	4	363 g	10 pcs.	20,30 kN
WB 22	4522	452201	2,0	70	155	75	34	4	440 g	10 pcs.	25,45 kN
WB 23	4523	452301	2,0	76	122	75	28	4	363 g	10 pcs.	20,30 kN
WB 24	4524	452401	2,0	76	152	75	34	4	440 g	10 pcs.	25,45 kN
WB 25	4525	452501	2,0	76	182	75	40	6	485 g	10 pcs.	27,75 kN
WB 26	4526	452601	2,0	80	120	75	28	4	363 g	10 pcs.	20,30 kN
WB 26 /6	452603	427101	2,0	80	120	75	28	4	2175 g	1 à 6 pcs.	20,30 kN
WB 27	4527	452701	2,0	80	150	75	34	4	440 g	10 pcs.	25,45 kN
WB 28	4528	452801	2,0	80	180	75	40	6	485 g	10 pcs.	27,75 kN
WB 29	4529	452901	2,0	80	210	75	46	6	555 g	10 pcs.	32,30 kN
WB 30	4530	453001	2,0	100	140	75	34	4	440 g	10 pcs.	25,45 kN
WB 3 /6	453003	427201	2,0	100	140	75	28	4	2640 g	1 à 6 pcs.	20,30 kN
WB 31	4531	453101	2,0	100	170	75	40	6	485 g	10 pcs.	27,75 kN
WB 32	4532	453201	2,0	100	200	75	46	6	555 g	10 pcs.	32,30 kN
WB 33	4533	453301	2,0	115	163	75	40	6	485 g	10 pcs.	27,75 kN
WB 34	4534	453401	2,0	115	193	75	46	6	555 g	10 pcs.	32,30 kN
WB 35	4535	453501	2,0	120	160	75	40	6	485 g	10 pcs.	27,75 kN
WB 36	4536	453601	2,0	120	190	75	46	6	555 g	10 pcs.	32,30 kN
WB 37	4537	453701	2,0	140	180	75	46	6	555 g	10 pcs.	32,30 kN
WB 38	4538	453801	2,0	160	170	75	46	6	555 g	10 pcs.	32,30 kN
WB 39	4539	453901	2,0	92	144	75	34	4	444 g	10 pcs.	-

DX51D + Z275MAC

tested by ITB ↑

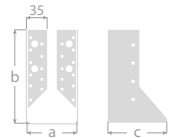
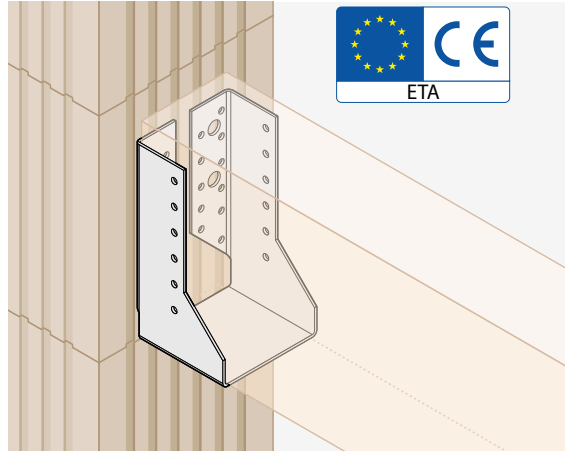
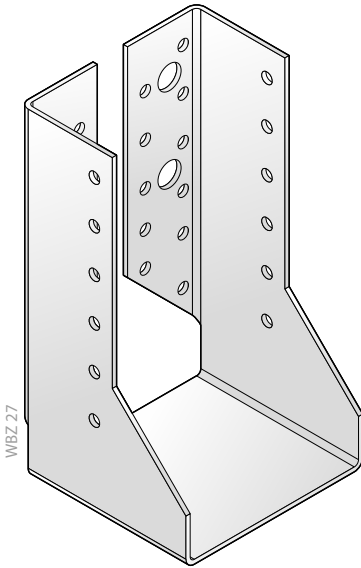

symbol	art. №		[mm]				qty ø		🧴	📦	F↓
	new	old	±	a	b	c	ø5	ø11			
WBZ 21	4561	456101	2,0	70	125	75	28	4	363 g	10 pcs.	12,75 kN
WBZ 22	4562	456201	2,0	70	155	75	34	4	440 g	10 pcs.	22,35 kN
WBZ 23	4563	456301	2,0	76	122	75	28	4	363 g	10 pcs.	12,75 kN
WBZ 24	4564	456401	2,0	76	152	75	34	4	440 g	10 pcs.	22,35 kN
WBZ 25	4565	456501	2,0	76	182	75	40	6	485 g	10 pcs.	30,95 kN
WBZ 26	4566	456601	2,0	80	120	75	28	4	363 g	10 pcs.	12,75 kN
WBZ 27	4567	456701	2,0	80	150	75	34	4	440 g	10 pcs.	22,35 kN
WBZ 28	4568	456801	2,0	80	180	75	40	6	485 g	10 pcs.	30,95 kN
WBZ 29	4569	456901	2,0	80	210	75	46	6	555 g	10 pcs.	28,65 kN
WBZ 30	4570	457001	2,0	100	140	75	34	4	440 g	10 pcs.	22,35 kN
WBZ 31	4571	457101	2,0	100	170	75	40	6	485 g	10 pcs.	30,95 kN
WBZ 32	4572	457201	2,0	100	200	75	46	6	555 g	10 pcs.	30,95 kN
WBZ 33	4573	457301	2,0	115	163	75	40	6	485 g	10 pcs.	28,65 kN
WBZ 34	4574	457401	2,0	115	193	75	46	6	555 g	10 pcs.	28,65 kN
WBZ 35	4575	457501	2,0	120	160	75	40	6	485 g	10 pcs.	30,95 kN
WBZ 36	4576	457601	2,0	120	190	75	46	6	555 g	10 pcs.	28,65 kN
WBZ 37	4577	457701	2,0	140	180	75	46	6	555 g	10 pcs.	28,65 kN
NEW WBZ 38	4578	457801	2,0	160	170	75	46	6	555 g	10 pcs.	28,65 kN

DX51D + Z275MAC

tested by ITB ↑

Wieszak belki lekki • Trámová botka lehká • Trámová papuča ľahká
 Lakši Nosač grede • Könnyű gerenda szeglemez C • Dispozitiv de agățare pt grindă ușor
 Крепление балки легкое • Пета за греда, олекотена • Soporte fijación alas exteriores fino
 Light joist hanger • Suspente de solive légère • Balkenschuh leicht

WL

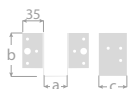
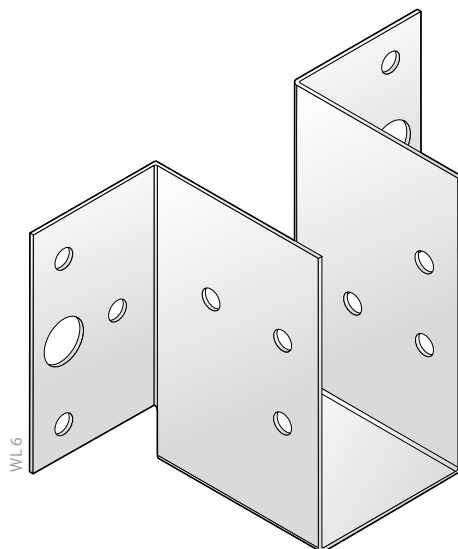

symbol	art. №		[mm]				Qty Ø				F ↓
	new	old	±	a	b	c	ø5	ø11			
WL 5	4555	454501	1,0	25	77	45	12	2	97 g	10 pcs.	14,29 kN
WL 6	4556	454601	1,0	38	71	45	12	2	97 g	10 pcs.	14,29 kN
WL 7	4557	454701	1,0	41	70	45	12	2	97 g	10 pcs.	14,29 kN
WL 8	4558	454801	1,0	51	65	45	12	2	97 g	10 pcs.	14,29 kN
WL 9	4559	454901	1,0	60	60	45	14	2	97 g	10 pcs.	14,29 kN

DX51D + Z275MAC

tested by ITB ↑

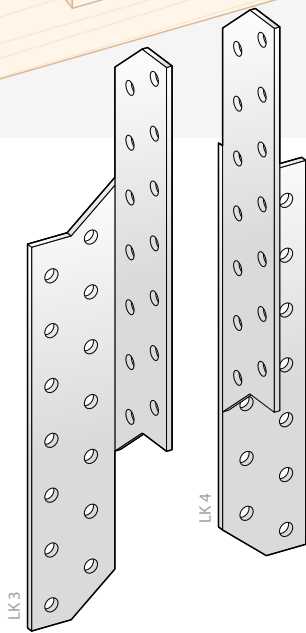
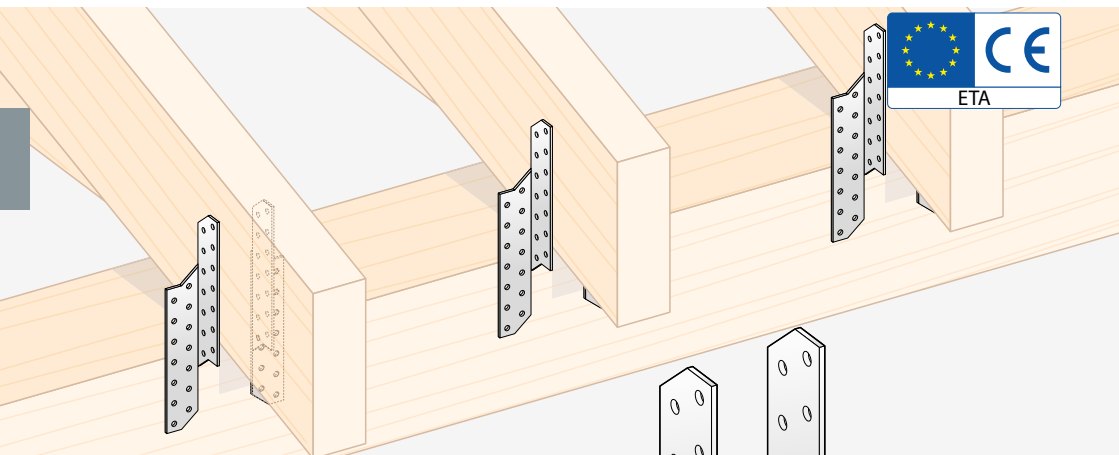

symbol	art. №		[mm]				qty ø	ø5	🧴	📦	F↓
	new	old	≠	a	b	type					
LK 1	4661	466101	2,0	170	32	L	20	95 g	20 pcs.	19,36 kN	
LK 2	4662	466201	2,0	170	32	P	20	95 g	20 pcs.	19,36 kN	
LK 3	4663	466301	2,0	210	32	L	28	132 g	20 pcs.	19,25 kN	
LK 4	4664	466401	2,0	210	32	P	28	131 g	20 pcs.	19,25 kN	
LK 5	4665	466501	2,0	250	32	L	36	186 g	20 pcs.	19,91 kN	
LK 6	4666	466601	2,0	250	32	P	36	186 g	20 pcs.	19,91 kN	
LK 7	4667	466701	2,0	290	32	L	44	208 g	20 pcs.	19,35 kN	
LK 8	4668	466801	2,0	290	32	P	44	208 g	20 pcs.	19,35 kN	

DX51D + Z275MAC

tested by ITB ↑

Kątownik gięty • Úhelník ohýbací • Uholník ohýbací
 Savijeni ugaonik • Sarokösszekötő lemez többfunkciós • Şablon de unghiuri curbat
 Уголок загнутый • Ъглова планка, извита • Ángulo plegado
 Folded angle • Corniere pliéée • Verbinder faltbar

KG

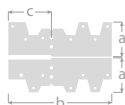
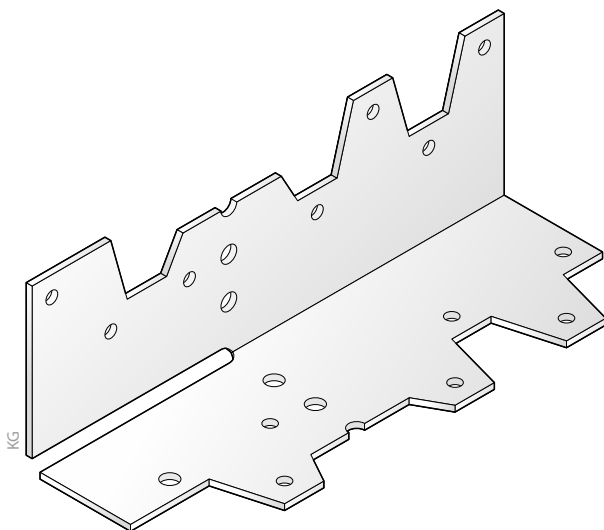
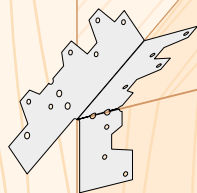

symbol	art. N°		≠	[mm]			qty ø		🔩	📦	F↓
	new	old		a	b	c	ø3	ø5			
KG	4620	462011	1,5	38	120	50	14	4	114 g	50 pcs.	-

DX51D + Z275MAC

tested by ITB ↑

2.33

KG

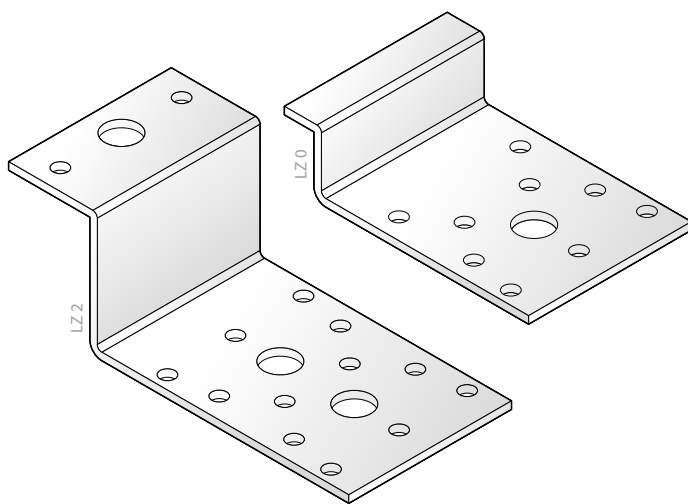
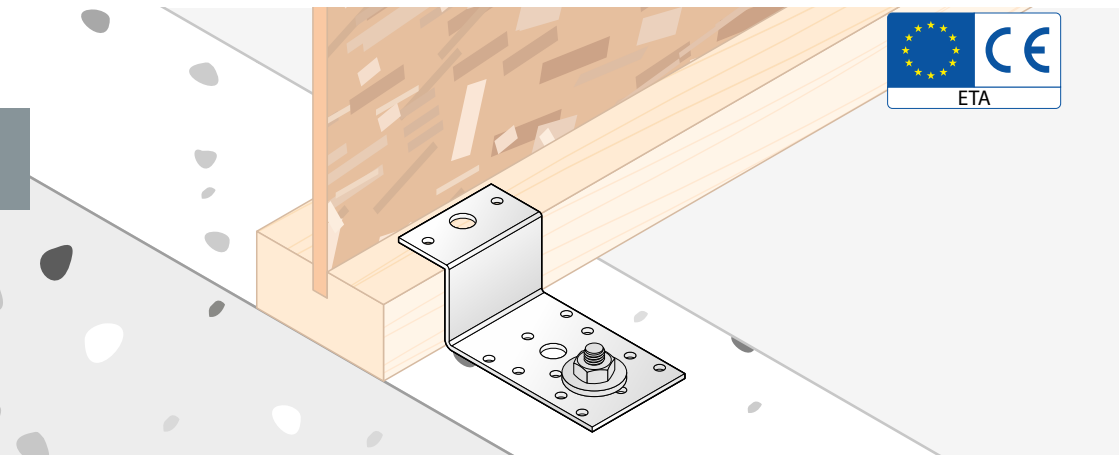



symbol	art. №		[mm]				qty ø		🧴	📦	F↓
	new	old	≠	a	b	c	ø5	ø11			
LZ 0	4619	461901	2,5	20	70	10	9	1	100 g	20 pcs.	3,62 kN
LZ 1	4621	462101	2,5	40	85	30	14	3	153 g	20 pcs.	3,62 kN
LZ 2	4622	462201	2,5	50	85	30	14	3	163 g	20 pcs.	3,62 kN
LZ 3	4623	462301	2,5	60	85	30	14	3	175 g	20 pcs.	3,62 kN

DX51D + Z275MAC

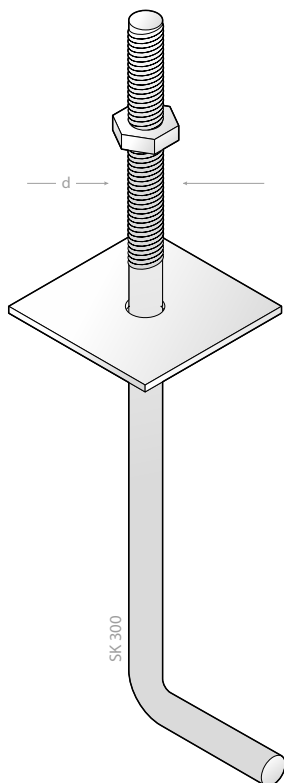
tested by ITB ↑



symbol	art. №		[mm]			
	new	old	a	d		
SK 250	7882	788231	250	M12	286 g	10 pcs.
SK 300	7883	788331	300	M12	324 g	10 pcs.
SK 350	7884	788431	350	M12	361 g	10 pcs.
SK 400	7885	788531	400	M12	393 g	10 pcs.
SK 450	7886	788631	450	M12	427 g	10 pcs.
SK 500	7887	788731	500	M12	468 g	10 pcs.
SK 700	7889	788931	700	M12	772 g	10 pcs.

S235 electrogalvanized

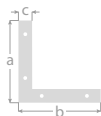
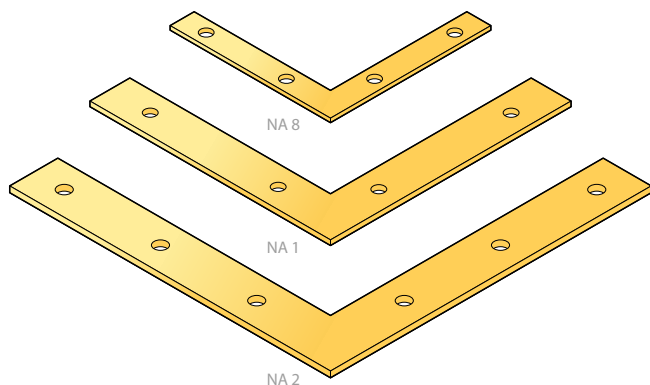



symbol	art. №		≠	[mm]			qty ∅		🧴	📦
	new	old		a	b	c	∅4	∅5		
NA 1	4651	465111	2,5	150	150	25	4	-	133 g	10 pcs.
NA 2	4652	465211	3,0	200	200	30	-	6	248 g	10 pcs.
NA 3	4653	465311	3,0	250	250	30	-	6	314 g	10 pcs.
NA 4	4654	465411	4,0	300	300	40	-	6	713 g	10 pcs.
NA 5	4655	465501	2,0	50	50	10	4	-	13 g	50 pcs.
NA 6	4656	465601	2,0	60	60	10	4	-	16 g	50 pcs.
NA 7	4657	465701	2,0	75	75	12	4	-	27 g	50 pcs.
NA 8	4658	465801	2,0	100	100	15	5	-	42 g	10 pcs.

DC01 electrogalvanized

Narožnik ozdobny • Rohovnik ozdobny • Rohovnik ozdobny
 Dekorativni ugaonik vrata • Dekorativ ajtó sarok • Colț decorativ
 Наугольник декоративный • Декоративен черен ъгълник • Ángulo de puerta decorativo
 Decorative door angle • Coin décoratif • Möbelwinkel dekorativ

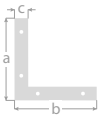
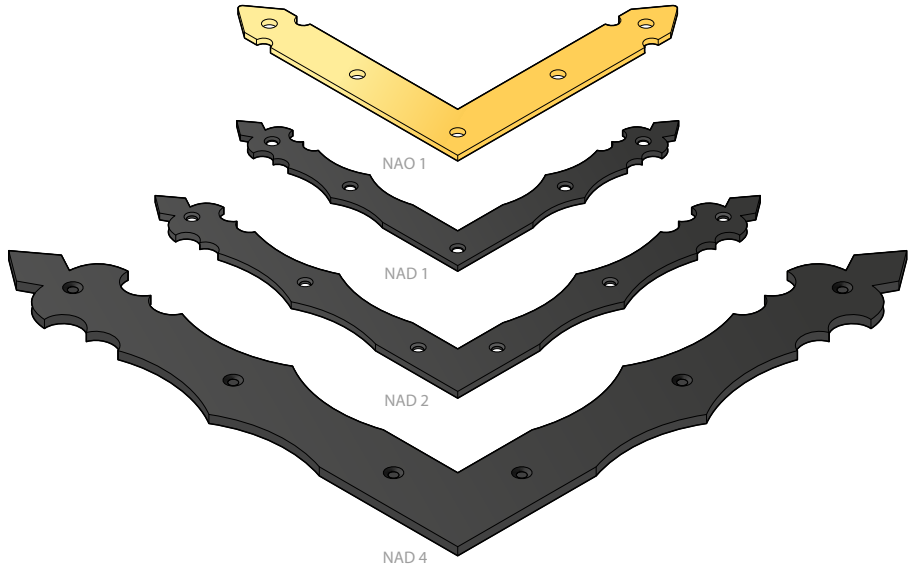

NAD

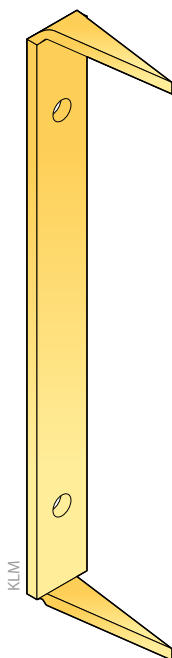

symbol	art. №		[mm]				qty ø				
	new	old	≠	a	b	c	ø3,5	ø4,5	ø5		
NAO 1	4660	729001	2,5	150	150	25	-	5	-	80 g	10 pcs.
NAD 1	89902	899021	2,5	150	150	25	-	-	5	103 g	10 pcs.
NAD 2	89912	899121	3,0	200	200	30	-	-	6	181 g	10 pcs.
NAD 4	89932	899321	4,0	300	300	40	-	-	6	624 g	10 pcs.
NAD 8	89972	899721	2,0	100	100	15	5	-	-	44 g	10 pcs.

NAO, DC01 electrogalvanized
 NAD 1,2,8: DC01 powder coating
 NAD 4: S235 powder coating





symbol	art. №		[mm]		qty	ø		
	new	old	≠	a				
KLM	4630	472801	5,0	250	2	ø5	263 g	10 pcs.

S235 electrogalvanized

Pierścień zębaty • Prsteneć zębaty dvoustranny • Prsteneć zębaty dvojstranny
 Dvostrano nazubljena spojnica • Szarufa-összekötő tárcsa • Inel dințat
 Диск шипованный • Шайба назъбена • Anilla dentada
 Double-side spiked plate • Couronne dentée • Einpressdübel

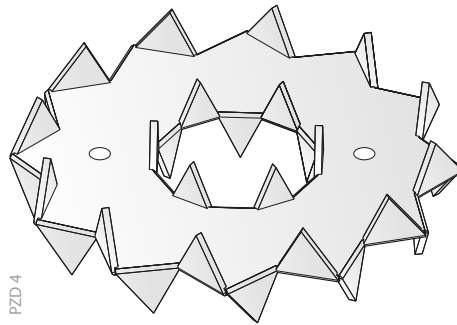
PZD



symbol	art. №		[mm]			qty ø		
	new	old	±	a	b			
PZD 1	4671	472101	1,5	48	17	0	12 g	20 pcs.
PZD 3	4673	472301	1,5	75	26	2	38 g	20 pcs.
PZD 4	4674	472411	1,5	95	33	2	91 g	20 pcs.

DX51D + Z275MAC

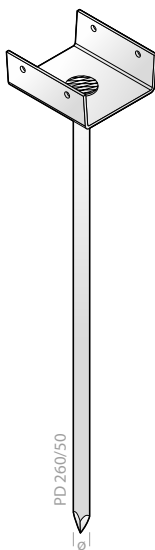
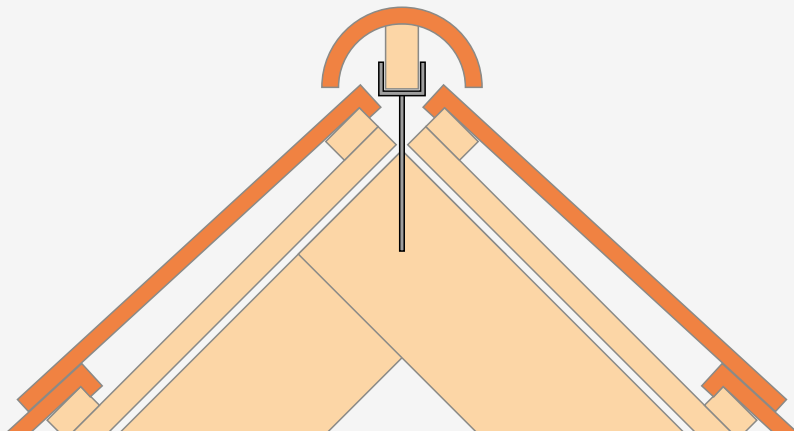

symbol	art. №		≠	[mm]			qty ø	ø3	137 g	1 pcs.
	new	old		a	b	ø				
PD 210/50	4610	473001	1,5	50	210	7	4	137 g	1 pcs.	
PD 260/50	4611	473101	1,5	50	260	7,5	4	164 g	1 pcs.	
PD 310/50	4612	473201	1,5	50	310	8	4	190 g	1 pcs.	
PD 210/40	4613	474001	1,5	40	210	7	4	137 g	1 pcs.	
PD 260/40	4614	474101	1,5	40	260	7	4	164 g	1 pcs.	
PD 310/40	4615	474201	1,5	40	310	7	4	190 g	1 pcs.	

DX51D + Z275MAC

PŁYTKI KOLCZASTE



Nośności

	$f_{s,0.0}$	$f_{s,0.950}$	k_1	k_2	α_0	$f_{t,0}$	$f_{t,90}$	$f_{c,0}$	$f_{c,90}$	$f_{t,0}$	$f_{t,90}$	γ_0	k_1
	[N/mm ²]	[N/mm ²]			[°]	[N/mm]	[N/mm]	[N/mm]	[N/mm]	[N/mm]	[N/mm]	[°]	
PK10 1 mm	2,61	2,16	-0,0054	0	90	148,2	182,4	128,7	72,6	84,8	72,6	1	0
PK15 1,5 mm	2,60	1,49	-0,0018	-0,0027	34,9	241	140	165	102	81	73	7	0,5

$\rho_s = 350 \text{ [kg/m}^3\text{]}$

Poslizg

Płytko	k_{pr}	ρ_{pr}
	[N/mm ²]	[kg/m ³]
PK 10 1 mm	11,1	504
PK15 1,5 mm	5,8	460

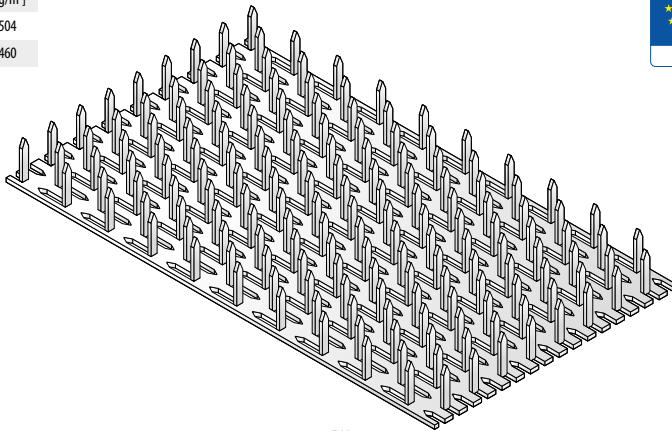



PK 15



symbol	art. №	÷	[mm]				
			a	b	c		
PK 15-715	4701	1,5	70	147	15	120 g	144 pcs.
PK 15-813	4702	1,5	84	126	15	120 g	192 pcs.
PK 15-815	4703	1,5	84	147	15	140 g	144 pcs.
PK 15-821	4704	1,5	84	210	15	210 g	96 pcs.
PK 15-825	4705	1,5	84	252	15	250 g	96 pcs.
PK 15-1011	4706	1,5	98	105	15	120 g	192 pcs.

DX51D + Z275MAC

symbol	art. №	≠	[mm]		c		
			a	b			
PK 15-1015	4707	1,5	98	147	15	170 g	144 pcs.
PK 15-1021	4708	1,5	98	210	15	240 g	96 pcs.
PK 15-1025	4709	1,5	98	252	15	290 g	96 pcs.
PK 15-1215	4710	1,5	119	147	15	200 g	108 pcs.
PK 15-1221	4711	1,5	119	210	15	290 g	96 pcs.
PK 15-1225	4712	1,5	119	252	15	350 g	72 pcs.
PK 15-1232	4713	1,5	119	315	15	440 g	48 pcs.
PK 15-1236	4714	1,5	119	357	15	500 g	48 pcs.
PK 15-1242	4715	1,5	119	420	15	580 g	48 pcs.
PK 15-1415	4716	1,5	140	147	15	240 g	72 pcs.
PK 15-1421	4717	1,5	140	210	15	340 g	48 pcs.
PK 15-1425	4718	1,5	140	252	15	410 g	48 pcs.
PK 15-1432	4719	1,5	140	315	15	520 g	48 pcs.
PK 15-1436	4720	1,5	140	357	15	580 g	24 pcs.
PK 15-1442	4721	1,5	140	420	15	690 g	24 pcs.
PK 15-1719	4722	1,5	168	189	15	370 g	36 pcs.
PK 15-1725	4723	1,5	168	252	15	500 g	48 pcs.
PK 15-1732	4724	1,5	168	315	15	620 g	24 pcs.
PK 15-1736	4725	1,5	168	357	15	700 g	24 pcs.
PK 15-1742	4726	1,5	168	420	15	830 g	24 pcs.
PK 15-1748	4727	1,5	168	483	15	950 g	24 pcs.
PK 15-1755	4728	1,5	168	546	15	1070 g	12 pcs.
PK 15-1763	4729	1,5	168	630	15	1240 g	12 pcs.
PK 15-1771	4730	1,5	168	714	15	1400 g	12 pcs.
PK 15-2021	4731	1,5	196	210	15	480 g	48 pcs.
PK 15-2025	4732	1,5	196	252	15	580 g	48 pcs.
PK 15-2032	4733	1,5	196	315	15	720 g	24 pcs.
PK 15-2036	4734	1,5	196	357	15	820 g	24 pcs.
PK 15-2042	4735	1,5	196	420	15	960 g	24 pcs.
PK 15-2048	4736	1,5	196	483	15	1110 g	24 pcs.
PK 15-2055	4737	1,5	196	546	15	1250 g	12 pcs.
PK 15-2063	4738	1,5	196	630	15	1440 g	12 pcs.
PK 15-2071	4739	1,5	196	714	15	1640 g	12 pcs.
PK 15-2425	4740	1,5	238	252	15	700 g	24 pcs.
PK 15-2432	4741	1,5	238	315	15	880 g	24 pcs.
PK 15-2436	4742	1,5	238	357	15	990 g	24 pcs.
PK 15-2442	4743	1,5	238	420	15	1170 g	24 pcs.
PK 15-2448	4744	1,5	238	483	15	1340 g	12 pcs.
PK 15-2455	4745	1,5	238	546	15	1520 g	12 pcs.
PK 15-2463	4746	1,5	238	630	15	1750 g	12 pcs.
PK 15-2474	4747	1,5	238	735	15	2050 g	12 pcs.

DX51D + Z275MAC

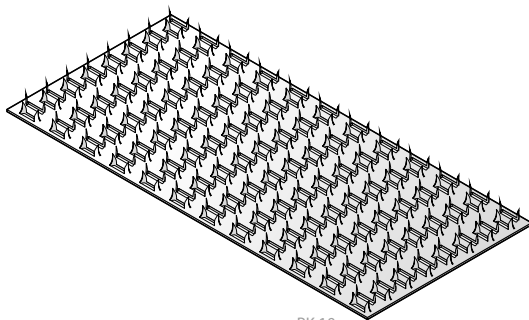

PK 10

symbol	art. №	≠	[mm]			🧴	📦
			a	b	c		
PK 10-313	4760	1	28	126	10	30 g	168 pcs.
PK 10-511	4761	1	42	105	10	40 g	168 pcs.
PK 10-813	4762	1	77	126	10	80 g	224 pcs.
PK 10-815	4763	1	77	147	10	90 g	168 pcs.
PK 10-821	4764	1	77	210	10	130 g	112 pcs.
PK 10-1111	4765	1	105	105	10	90 g	224 pcs.
PK 10-1115	4766	1	105	147	10	130 g	168 pcs.
PK 10-1119	4767	1	105	189	10	160 g	112 pcs.
PK 10-1121	4768	1	105	210	10	180 g	112 pcs.
PK 10-1125	4769	1	105	252	10	220 g	112 pcs.
PK 10-1132	4770	1	105	315	10	270 g	56 pcs.
PK 10-1413	4771	1	133	126	10	140 g	168 pcs.
PK 10-1415	4772	1	133	147	10	160 g	126 pcs.
PK 10-1421	4773	1	133	210	10	230 g	84 pcs.
PK 10-1425	4774	1	133	252	10	270 g	84 pcs.
PK 10-1432	4775	1	133	315	10	340 g	42 pcs.
PK 10-1436	4776	1	133	357	10	390 g	42 pcs.
PK 10-1615	4777	1	154	147	10	180 g	126 pcs.
PK 10-1621	4778	1	154	210	10	260 g	84 pcs.
PK 10-1625	4779	1	154	252	10	310 g	84 pcs.
PK 10-1632	4780	1	154	315	10	390 g	42 pcs.
PK 10-1815	4781	1	175	147	10	210 g	84 pcs.
PK 10-1821	4782	1	175	210	10	300 g	56 pcs.
PK 10-1825	4783	1	175	252	10	360 g	56 pcs.
PK 10-1832	4784	1	175	315	10	450 g	28 pcs.
PK 10-2015	4785	1	196	147	10	230 g	84 pcs.
PK 10-2021	4786	1	196	210	10	330 g	56 pcs.
PK 10-2025	4787	1	196	252	10	400 g	56 pcs.
PK 10-2032	4788	1	196	315	10	500 g	28 pcs.

DX51D + Z275MAC

Łączniki na zamówienie

Proponujemy wykonanie niestandardowych łączników i innych wyrobów z metalu w oparciu o wykorzystanie technologii: cięcia laserowego, wykrawania i zaginania CNC. Możliwości nasze obejmują obróbkę blach czarnych, cynkowanych, nierdzewnych i z aluminium w zakresie grubości od 0,5 mm do 20 mm.

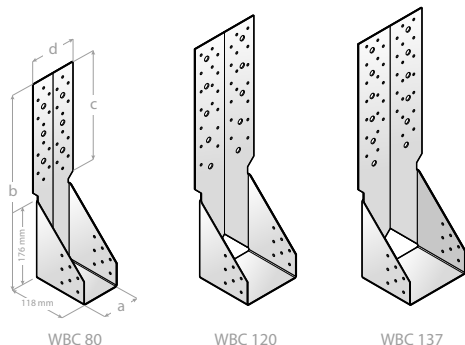

Wieszaki belek ciężkie WBC

symbol	art.	≠	[mm]			
			a	b	c	d
WBC 80	na zamówienie	2	80	428	260	100
WBC 92	na zamówienie	2	92	443	275	114
WBC 100	na zamówienie	2	100	443	275	120
WBC 120	na zamówienie	2	120	505	337	148
WBC 137	na zamówienie	2	137	515	347	160

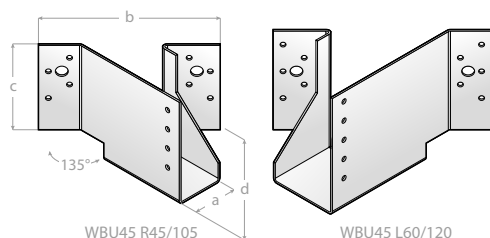

Wieszaki belek 45° WBU45

symbol	art.	≠	[mm]			
			a	b	c	d
WBU45 R45/105	na zamówienie	2	45	155	88	105
WBU45 L45/105	na zamówienie	2	45	155	88	105
WBU45 R50/105	na zamówienie	2	50	162	88	105
WBU45 L50/105	na zamówienie	2	50	162	88	105
WBU45 R60/120	na zamówienie	2	60	176	103	120
WBU45 L60/120	na zamówienie	2	60	176	103	120

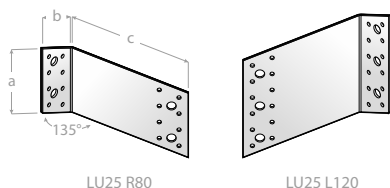

Łączniki ukośne LU25

symbol	art.	≠	[mm]		
			a	b	c
LU25 R80	na zamówienie	2	89	51	158
LU25 L80	na zamówienie	2	89	51	158
LU25 R120	na zamówienie	2	133	51	158
LU25 L120	na zamówienie	2	133	51	158

Chętnie doradzimy, wycenimy jak również wykonamy dla Państwa projekty potrzebnych elementów.

Ponadto możemy zaoferować pokrycia: malowane proszkowo, cynkowane ogniowo lub elektrolizacyjnie.

DMX[®] SD
 SYSTEM
 A+B+C

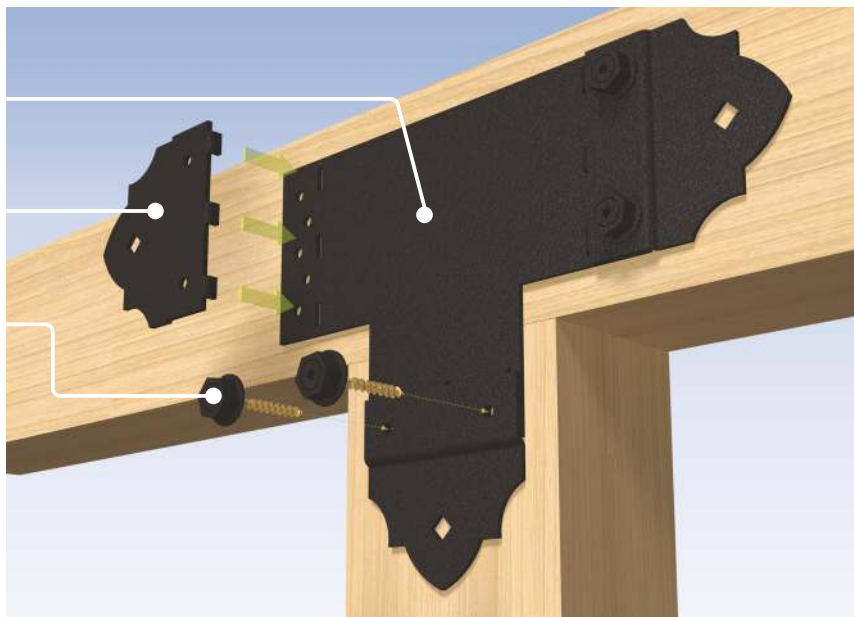
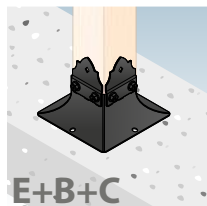

symbol	art. №	≠	[mm]			🍷	📦	F↓
			a	b	c			
SD LP A1	89531	2,5	76	-	85	112 g	6 pcs.	6,4 kN
SD LP A2	89532	2,5	116	-	85	179 g	6 pcs.	12 kN
SD LP A3	89533	2,5	156	-	85	246 g	6 pcs.	13,1 kN
SD LP B1	89541	2,5	207	146	85	425 g	6 pcs.	10,5 kN
SD LP C1	89551	2,5	315	200	85	1002 g	6 pcs.	9,9 kN
SD LP D1	89561	2,5	146	146	85	331 g	6 pcs.	9,3 kN
SD LP E1	89571	2,5	176	155	85	382 g	6 pcs.	13,1 kN
SD LP F1	89581	2,5	176	155	85	382 g	6 pcs.	13,1 kN
SD LZ 1	89501	2,5	98	28	85	179 g	6 pcs.	3,6 kN
SD KL 1	89521	2,5	61	61	85	179 g	6 pcs.	3,3 kN
SD KLR 1	89511	2,5	61	61	85	179 g	6 pcs.	3,3 kN
SD D85 A	89701	2,5	85	-	85	105 g	6 à 2 pcs.	- kN
SD D85 B	89702	2,5	85	-	85	106 g	6 à 2 pcs.	- kN
SD P100 A	89811	2,0	106	90	101	731 g	1 pcs.	39,6 kN
SD P120 A	89821	2,0	126	97	121	914 g	1 pcs.	39,6 kN
SD P90 A	89801	2,0	96	90	91	644 g	1 pcs.	39,6 kN
SD P90 B	89802	2,0	197	97	91	905 g	1 pcs.	180,6 kN
SD P100 B	89812	2,0	207	97	101	960 g	1 pcs.	220,5 kN
SD P120 B	89822	2,0	227	97	121	1135 g	1 pcs.	312,9 kN
SD CS50	38802					15 g	6 à 12 pcs.	- kN

DX51D + Z275MAC

NEW

2.46

SD

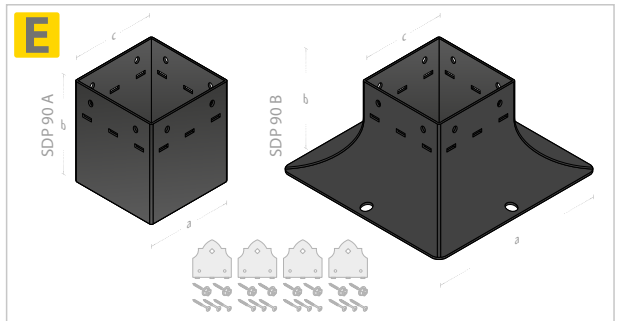
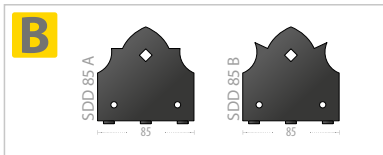
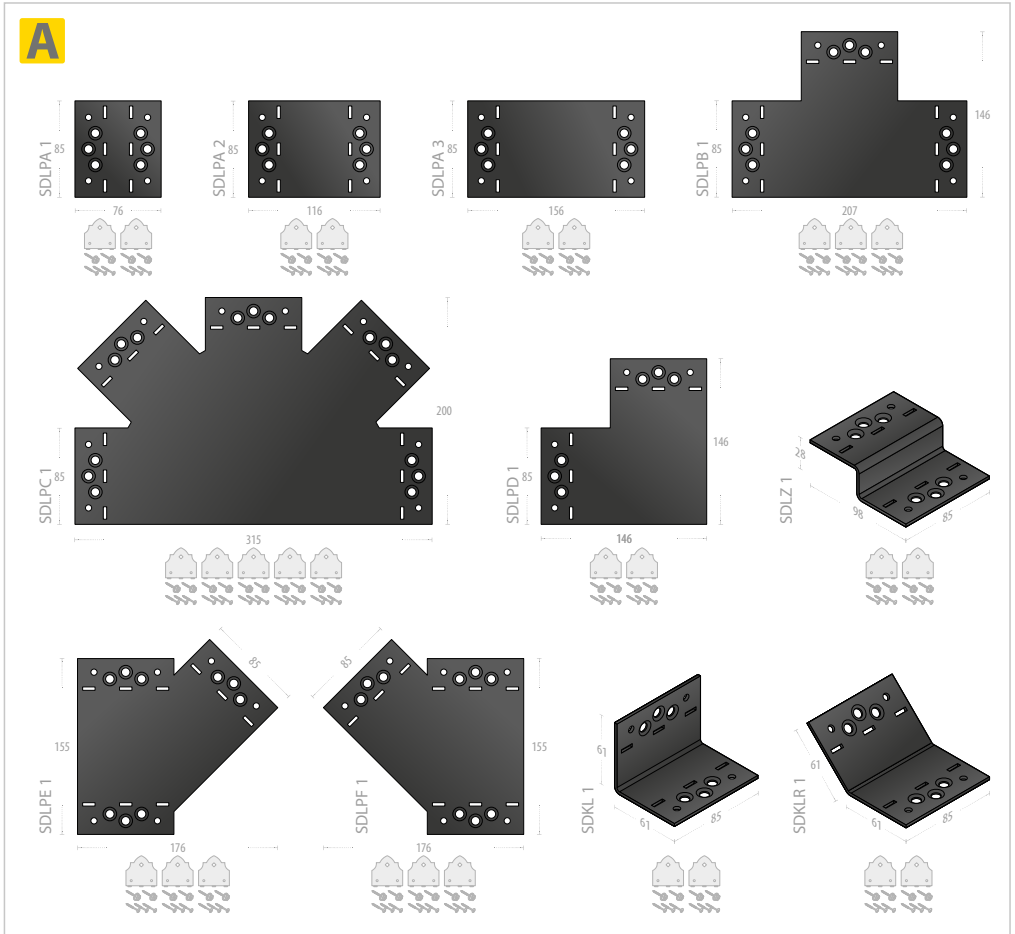

NEW

2.47

SD

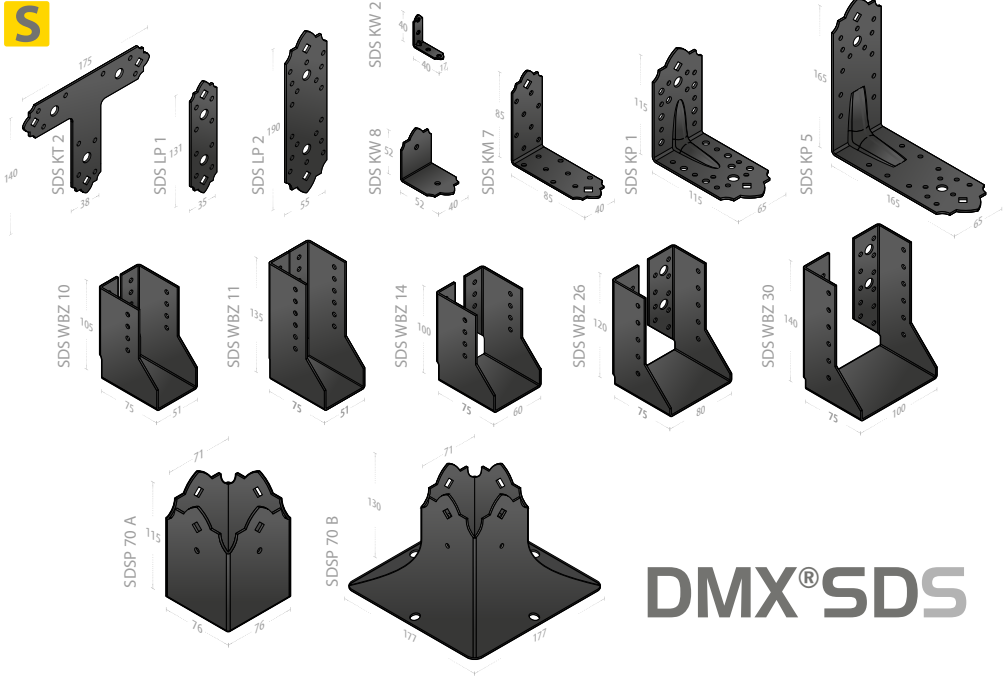

DMX® SDS

symbol	art. №	[mm]			🧰	📦	F↓	
		±	a	b				c
SDS KT 2	89892	2,5	171	155	38	140 g	10 pcs.	3,5 kN
SDS LP 1	89881	2,5	131	-	35	70 g	10 pcs.	3,5 kN
SDS LP 2	89882	2,5	190	-	55	166 g	10 pcs.	3,7 kN
SDS KM 7	89877	2,0	98	98	40	110 g	10 pcs.	5,8 kN
SDS KP 5	89865	2,5	165	165	65	380 g	10 pcs.	10,9 kN
SDS KP 1	89861	2,5	115	115	65	248 g	10 pcs.	17,8 kN
SDS KW 8	89858	2,0	52	52	40	39 g	50 pcs.	3,5 kN
SDS KW 2	89852	1,5	40	40	17	14 g	50 pcs.	3,3 kN
SDS WBZ 26	899826	2,0	80	120	75	371 g	6 pcs.	17,2 kN
SDS WBZ 11	899811	2,0	51	135	75	379 g	6 pcs.	12,3 kN
SDS WBZ 14	899814	2,0	60	100	75	309 g	6 pcs.	9,6 kN
SDS WBZ 21	899821	2,0	70	125	75	371 g	6 pcs.	17,2 kN
SDS WBZ 30	899830	2,0	100	140	75	441 g	6 pcs.	22,4 kN
SDS WBZ 10	899810	2,0	51	105	75	309 g	6 pcs.	9,6 kN
SDS P70 A	89991	2,0	71	76	115	535 g	1 pcs.	34,8 kN
SDS P70 B	89992	2,0	71	177	130	847 g	1 pcs.	108,6 kN

DX51D + Z275M4C



ZŁĄCZA OGRODOWE

ZAHRADNÍ SPOJKY

ZAHRADNÉ SPOJKY

BASTENSKI PROGRAM

PILLER TAMASZ

RACORDURI DE GRADINĂ

СОЕДИНЕНИЯ САДОВЫХ КОНСТРУКЦИЙ

СЪЕДИНИТЕЛНИ ЕЛЕМЕНТИ ЗА ГРАДИНАТА

FIJACIONES PARA POSTES

POST SUPPORTS

JOINTS DE JARDIN

GARTEN- UND HOLZBESCHLÄGE



dmxsystem.com



Podstawa słupa wbijana • Patka sloupku k zarálení • Pätka stfipiku nabijacia
 Nosač stuba u zemlji • Beütő padlóhüvely kerek • Suport de stîlp bătut
 Основание столба для вбивания • Основа за колона, набивна • Pletina cuadrada con punta
 Drive-in post support • Base de poteau enfoncée • Einschlagbodenhülse

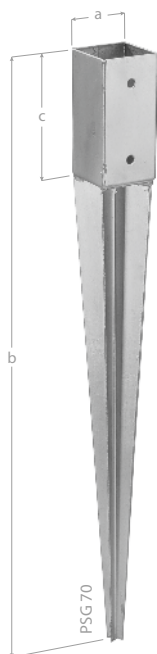

PSG



symbol	art. №		[mm]				qty ø			
	new	old	≠	a	b	c	ø8	ø11		
PSG 45/550	4816	481611	1,5	46	550	100	4	-	840 g	1 pcs.
PSG 70/750	4821	482111	2,0	71	750	150	-	4	1460 g	1 pcs.
PSG 90/750	4822	482211	2,0	91	750	150	-	4	1800 g	1 pcs.
PSG 100/900	4824	482411	2,0	101	900	150	-	4	2100 g	1 pcs.
PSG 120/900	4827	482711	2,0	121	900	150	-	4	2700 g	1 pcs.

S235, JRG2 electrogalvanized



symbol	art. №		≠	[mm]			qty ø		
	new	old		ø	a	b			
PSPO 80	4844	484401	2	81	150	150	12	849 g	1 pcs.
PSPO 100	4845	484501	2	101	150	150	12	1180 g	1 pcs.

S235, JRG2 electrogalvanized

Podstawa słupa z podstawą prostokątną • Patka sloupku se čtvercovou základnou • Pätka stĺpiku so štvorc. Základňou
 Nosač stuba površinski • Oszlophüvely lecsavarozható szögletes • Suport de stîlp cu bază dreptunghiulară
 Основание столба прямоугольное • Основа за колона с правоъгълна основа • Pletina cuadrada de base plana
 Down postfoot • Base de poteau avec une base rectangulaire • Aufschraubhülse

PSP

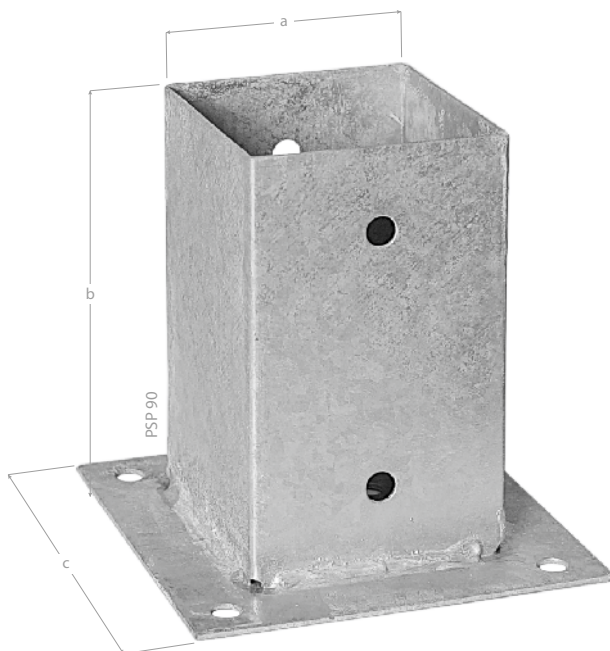

symbol	art. №		≠	[mm]			qty	ø	🔧	📦
	new	old		a	b	c				
PSP 70	4841	484101	2	71	150	150	12	939 g	1 pcs.	
PSP 90	4842	484201	2	91	150	150	12	1040 g	1 pcs.	
PSP 100	4843	484301	2	101	150	150	12	1345 g	1 pcs.	
PSP 120	4846	484601	2	121	150	180	12	1740 g	1 pcs.	

S235, JRG2 electrogalvanized

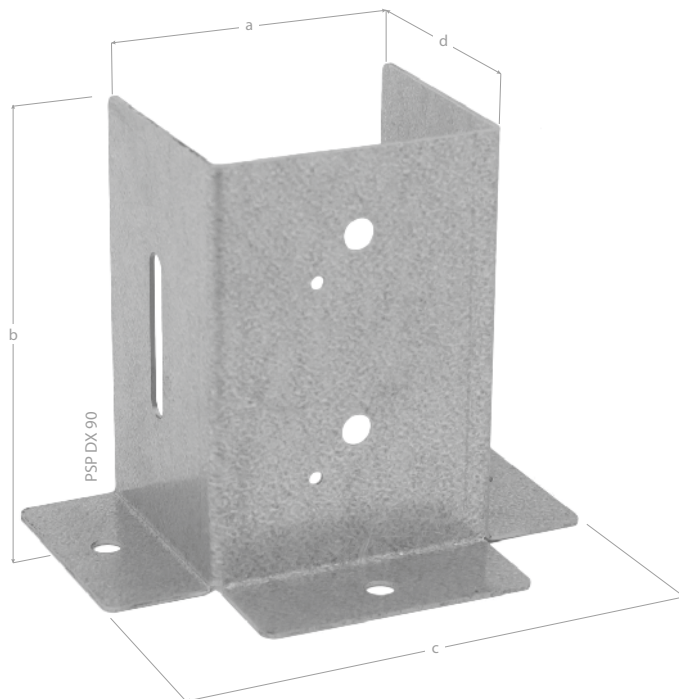



symbol	art. №		[mm]					qty ø			[mm]		📦	📦
	new	old	≠	a	b	c	d	ø5	ø7	ø11	ø7/33	ø11/67		
PSP DX 45	4851	484741	1,5	46	102	160	46	-	2	3	2	-	300 g	10 pcs.
PSP DX 70	4852	484141	2,0	71	152	151	65	4	-	5	-	2	650 g	10 pcs.
PSP DX 90	4853	484241	2,0	91	152	171	85	4	-	5	-	2	735 g	10 pcs.
PSP DX 100	4854	484341	2,0	101	152	181	95	4	-	5	-	2	980 g	10 pcs.
PSP DX 120	4855	484641	2,0	121	152	200	116	4	-	5	-	2	940 g	10 pcs.

S235, JRG2 electrogalvanized

Podstawa słupa typ TT • Patka sloupku typu TT • Pätka stlpiku typu TT
 TT-Tip nosač • Oszloptalp U erősített • Suport de stîlp tip TT
 Основание столба тип TT • Основа за колона тип TT • Anclaje para poste en forma de TT
 TT-type postfoot • Base de poteau type TT • Pfostenständer typ TT verstärkt zum Ausrauben

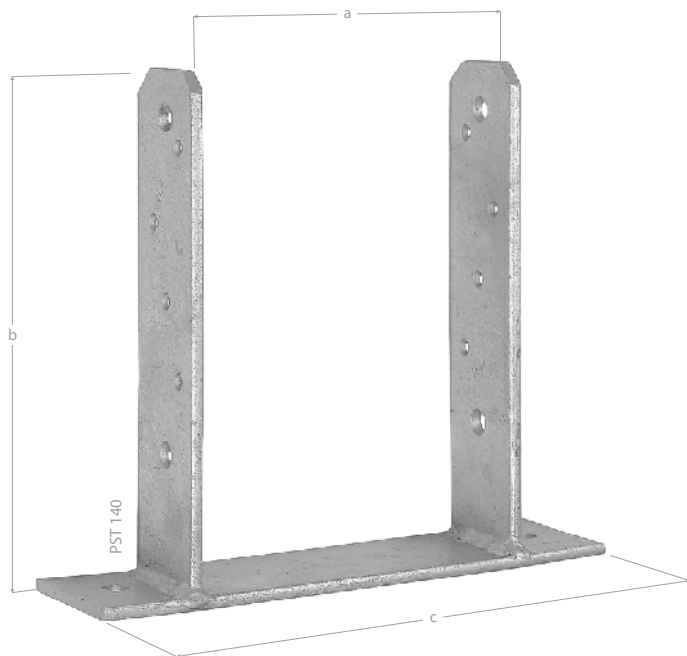
PST



symbol	art. №		[mm]				qty ø			
	new	old	≠	a	b	c	ø7	ø11		
PST 70	4861	486101	5	71	200	160	8	8	1157 g	1 pcs.
PST 90	4863	486301	5	91	200	180	8	8	1247 g	1 pcs.
PST 100	4864	486401	5	101	200	190	8	8	1280 g	1 pcs.
PST 120	4865	486501	5	121	200	210	8	8	1311 g	1 pcs.
PST 140	4866	486601	5	141	200	230	8	8	1383 g	1 pcs.

S235, JRG2 electrogalvanized

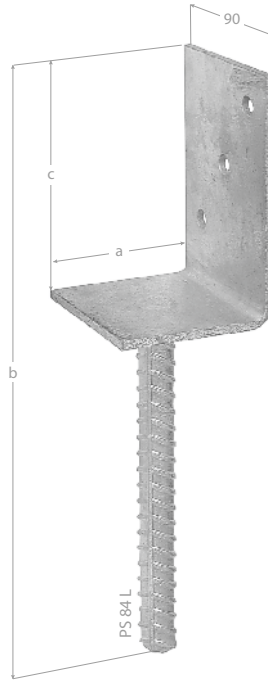
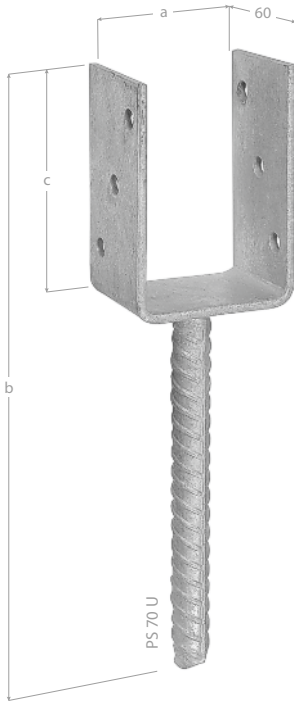



symbol	art. №		≠	[mm]			qty	ø	📦	📦
	new	old		a	b	c				
PS 60U	4801	480101	4	61	324	120	6	853 g	6 pcs.	
PS 70U	4802	480221	4	71	324	120	6	918 g	6 pcs.	
PS 80U	4803	480301	4	81	325	120	6	970 g	6 pcs.	
PS 90U	4804	480401	4	91	325	120	6	988 g	6 pcs.	
PS 100U	4805	480501	4	101	325	120	6	1012 g	6 pcs.	
PS 120U	4806	480601	4	121	325	120	6	1030 g	6 pcs.	
PS 140U	4808	480801	4	141	325	120	6	1109 g	6 pcs.	
PS 84L	4807	480701	5	84	325	120	3	1291 g	6 pcs.	

S235, JRG2 electrogalvanized

Podstawa słupa lekka typ U • Patka sloupku lehká typu U • Pätka stĺpiku ľahká typu U
 Klasični anker grede (lakši) • Oszloptalp U beépíthető könnyű • Suport de stîlp ușor tip U
 Основание столба тип U • Основа за колона олекотена, тип U • Soporte en forma de U (Ligero)
 Classic postfoot (light) • Base de poteau légère type U • Pfostenträger Typ U leicht



PSL

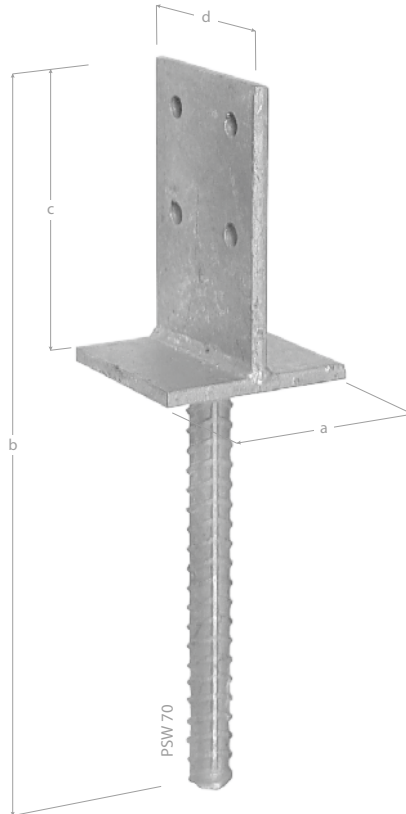

symbol	art. №		[mm]				qty ø			
	new	old	≠	a	b	c	ø7	ø9		
PSL 50U	4910	491001	5	51	310	100	8	2	755 g	6 pcs.
PSL 70U	4913	491301	5	71	310	100	8	2	786 g	6 pcs.
PSL 90U	4916	491601	5	91	310	100	8	2	803 g	6 pcs.
PSL 100U	4918	491801	5	101	310	100	8	2	815 g	6 pcs.

S235, JRG2 electrogalvanized





symbol	art. №		≠	[mm]				qty	ø		
	new	old		a	b	c	d				
PSW 70	4933	493301	8	71	336	130	70	4	1420 g	6 pcs.	
PSW 90	4934	493401	8	91	338	130	90	4	1793 g	6 pcs.	

S235, JRG2 electrogalvanized

Podstawa słupa • Patka sloupku • Pätka stłpiku
 Klasični anker grede • Oszloptalp beépíthető • Suport de stîlp
 Основание столба • Основа за колона • Sororte
 Classic postfoot • Base de poteau • Pfostenträger

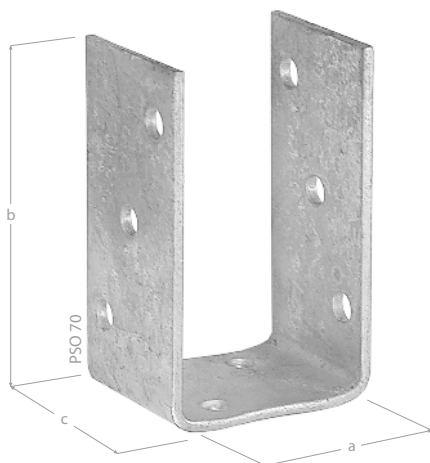
PSO



symbol	art. №		[mm]				qty ø			
	new	old	≠	a	b	c	ø11	ø14		
PSO 70	4832	483201	4	71	120	60	8	-	599 g	10 pcs.
PSO 80	4833	483301	5	81	120	60	8	1	728 g	10 pcs.
PSO 90	4834	483401	5	91	120	60	8	1	757 g	10 pcs.
PSO 100	4835	483501	5	101	120	60	8	1	839 g	10 pcs.
PSO 120	4836	483601	5	121	120	60	8	1	844 g	10 pcs.

S235, JRG2 electrogalvanized

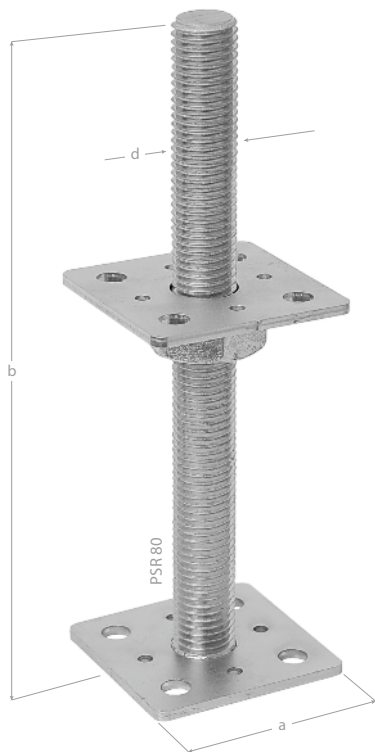



symbol	art. №		≠	[mm]			qty ø		📦	📦
	new	old		a	b	d	ø5	ø11		
PSR 80	4888	488801	4	80	250	M24	8	8	1145 g	4 szt.
PSR 110	4889	488901	4	110	250	M24	8	8	1505 g	4 szt.

S235 electrogalvanized

Kotwa wkręcana do ziemi oc. • Kotva na zavrtanie do zeme • Kotva na zavrtanie do zeme
 Ključ-anker • Lerögzítő rúd csavarozható • Ancoră montată în pământ zincată
 Анкер стабилизирующий • Анкер, завинтован в землю • Anclaje de suelo con tornillo
 In-lock anchor • Base de poteau vissée dans le sol • Einschraub Stützenfuß

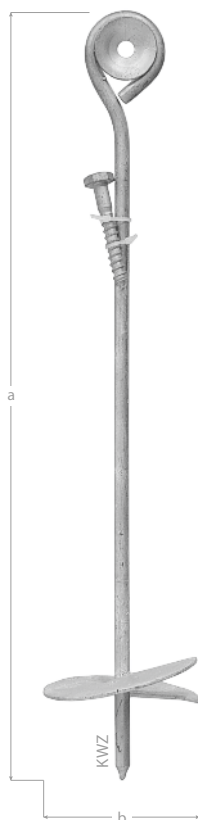
KWZ



symbol	art. №		[mm]			
	new	old	a	b		
KWZ	4830	493001	470	100	500 g	1 pcs.

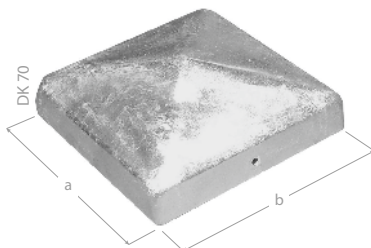
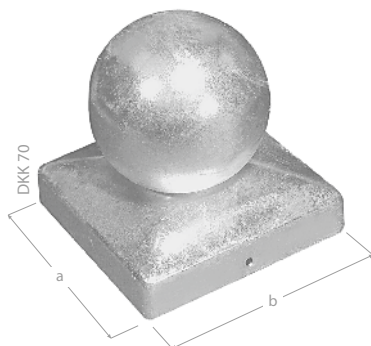



symbol	art. №		[mm]			🧴	📦
	new	old	±	a	b		
DKK 70	4995	499511	1,0	70	70	220 g	10 pcs.
DKK 90	4997	499711	1,0	90	90	216 g	10 pcs.
DK 70	4985	498511	1,0	70	70	90 g	10 pcs.
DK 90	4987	498711	1,0	90	90	122 g	10 pcs.

DC01 electrogalvanized

Uchwyt deski • Úchyt lamely • Opláštená konzola
 Fence nosač • Kerítéstartó konzol • Mīner de scīndurā
 Захват доск • Приспособление за захващане на дъска • Soporte para valla
 Fence bracket • Attache de planche • Zaunbretthalter

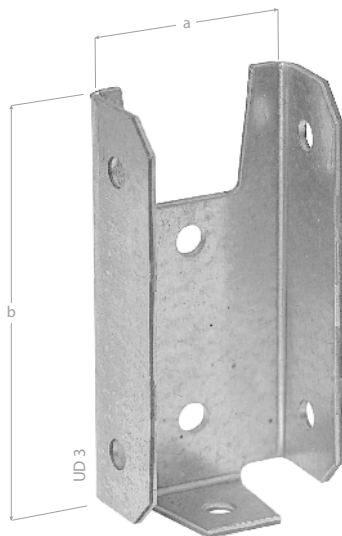

UD



symbol	art. №		[mm]			qty \varnothing		
	new	old	\neq	a	b			
UD 2	4632	459201	1,5	25	70	7	54 g	10 pcs.
UD 3	4633	459301	1,5	32	70	7	54 g	10 pcs.

DXS1D + Z275MAC



symbol	art. №		≠	[mm]			qty ø		
	new	old		a	b	c			
OP	4625	462511	2	30	38	30	2	42 g	50 pcs.

DC01 electrogalvanized

Łącznik belki okrągłej • Spojka kulatych trámů • T střípková spojka
 T konektor za okruglu gradju • Oszlop összekötő T • Legătură pt grindă rotundă
 Крепление круглой балки • Връзка за кръгла летва • Conector para viga redonda
 T post connector • Joint de poutre ronde • Zaun-Riegelbeschlag

LBO

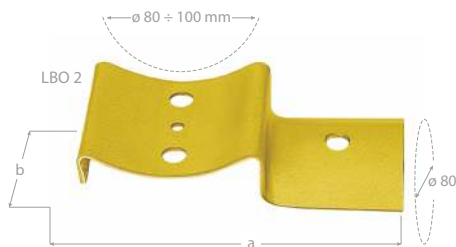
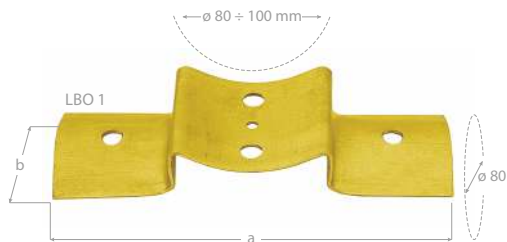

symbol	art. №		[mm]			qty ø			
	new	old	≠	a	b	ø5	ø11		
LBO 1	4927	492711	2,5	203	68	1	4	320 g	4 pcs.
LBO 2	4928	492811	2,5	145	68	1	3	240 g	4 pcs.
LBO 3	4929	492901	2,5	200	58	1	2	260 g	4 pcs.

DC01 electrogalvanized

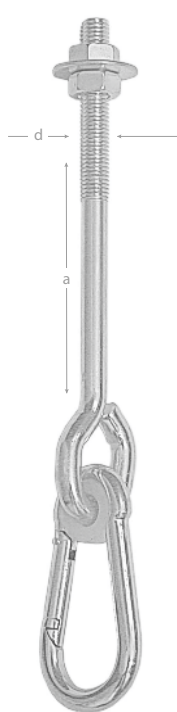

MHA 130

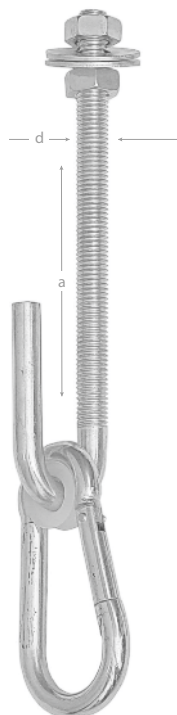

MHB 130

symbol	art. №		[mm]		kg	g	pcs.
	new	old	a	d			
MHA 110	8850	885001	110	M12	70 kg	340 g	10 pcs.
MHA 130	8851	885101	130	M12	70 kg	380 g	10 pcs.
MHB 130	8852	885201	130	M12	70 kg	360 g	10 pcs.

3.16

MHA
MHB

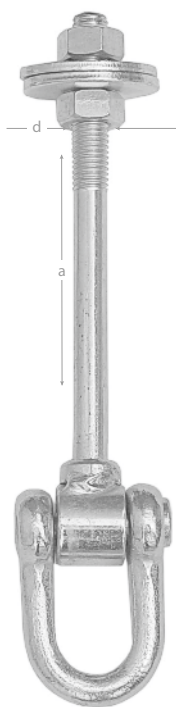

MHC 120

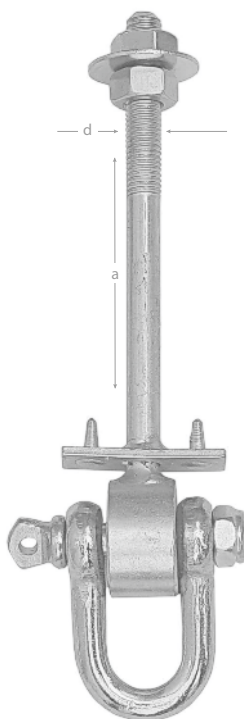

MHD 120

symbol	art. №		[mm]		kg	g	pcs.
	new	old	a	d			
MHC 120	8853	885301	120	M12	70 kg	440 g	10 pcs.
MHC 130	8854	885401	130	M12	70 kg	460 g	10 pcs.
MHD 120	8855	885501	120	M12	70 kg	460 g	10 pcs.
MHD 130	8856	885501	130	M12	70 kg	480 g	10 pcs.



MHK 90



MHO 100

symbol	art. №		[mm] max	kg	g	pcs.
	new	old				
MHK 90	8859	885901	90	70 kg	480 g	10 pcs.
MHO 80	8860	886001	80	70 kg	440 g	10 pcs.
MHO 100	8857	885701	100	70 kg	440 g	10 pcs.
MHO 120	8858	885801	120	70 kg	480 g	10 pcs.

DC01 electrogalvanized



ZASUWY I ZAWIASY

ZÁSTRČE A ZÁVĚSY

ZÁSTRČE A ZÁVĚSY

SARKE I REZE

TOLÓZÁRAK KIVETŐRÁNTOK

ZÁVOARE ȘI SARNIERE

ПЕТЛИ И ЗАДВИЖКИ

РЕЗЕТА И ПАНТИ

PASADORES Y BISAGRAS

BOLTS & HINGES



VERROUS ET CHARNIERES

RIEGEL UND SCHARNIERE

Zawias splatany • Závěs splétaný • Závés splietaný
 Šarka ravna • Csuklópánt keskeny • Şarnieră armurată
 Петля универсальная • Шарнирна панта • Bisagra de trenza
 Plait hinge • Charnière épissée • Scharnier

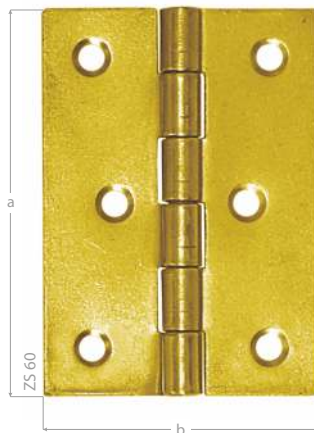
ZS



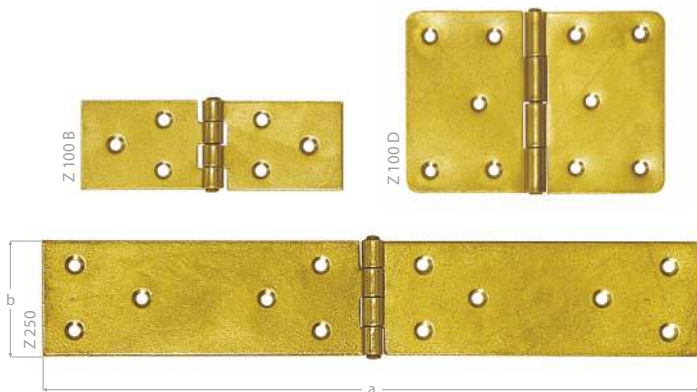

symbol	art. №		[mm]			qty ø				 	
	new	old	≠	a	b	ø1,5	ø3,5	ø4	ø4,5		
ZS 20 /10	80101	801011	0,5	20	17	4	-	-	-	20 g	20 à 10 pcs.
ZS 25 /10	80111	801111	1,0	25	24	-	4	-	-	50 g	10 à 10 pcs.
ZS 30 /10	80121	801211	1,0	30	29	-	4	-	-	80 g	10 à 10 pcs.
ZS 35 /10	80131	801311	1,0	35	35	-	4	-	-	110 g	10 à 10 pcs.
ZS 40	8014	801401	1,0	40	40	-	-	6	-	15 g	100 pcs.
ZS 45	8015	801501	1,0	45	40	-	-	6	-	17 g	100 pcs.
ZS 50	8016	801601	1,0	50	42	-	-	-	6	23 g	50 pcs.
ZS 60	8017	801701	1,0	60	43	-	-	6	-	29 g	50 pcs.
ZS 70	8018	801801	1,0	70	43	-	-	-	6	34 g	50 pcs.
ZS 80	8019	801901	1,5	80	56	-	-	-	6	68 g	20 pcs.

DC01 electrogalvanized



Istnieje możliwość zamówienia w ilościach hurtowych zawiasów o wymiarach nie wymienionych w poniższej tabeli więcej informacji po nr tel. 58 665 82 22



symbol	art. №		[mm]			qty ø						
	new	old	±	a	b	ø4	ø4,5	ø5	ø5,5	ø6		
Z 50/25	8021	802101	1,5	50	25	4	-	-	-	-	20 g	20 pcs.
Z 60/55	8022	802201	2,5	60	55	-	-	-	-	4	20 g	20 pcs.
Z 75/75	8020	802001	1,8	75	75	-	-	-	6	-	93 g	20 pcs.
Z 100/25	8023	802301	1,5	100	25	-	8	-	-	-	35 g	10 pcs.
Z 100/35	8024	802401	1,5	100	35	-	-	6	-	-	60 g	10 pcs.
Z 100/45	8025	802501	1,5	100	45	-	-	6	-	-	80 g	10 pcs.
Z 100/70	8041	804101	1,5	100	70	-	-	-	-	-	100 g	10 pcs.
Z 115/90	8042	804201	2,5	115	90	-	-	-	-	8	230 g	10 pcs.
Z 135/120	8043	804301	2,5	135	120	-	-	-	-	10	387 g	10 pcs.
Z 150/25	8026	802601	1,5	150	25	12	-	-	-	-	60 g	10 pcs.
Z 150/35	8027	802701	1,5	150	35	10	-	-	-	-	80 g	10 pcs.
Z 150/45	8028	802801	1,5	150	45	-	8	-	-	-	100 g	10 pcs.
Z 150/55	8029	802901	2,5	150	55	-	-	-	10	-	191 g	10 pcs.
Z 200/35	8031	803101	1,5	200	35	-	10	-	-	-	100 g	10 pcs.
Z 200/45	8032	803201	1,5	200	45	-	10	-	-	-	140 g	10 pcs.
Z 250/45	8033	803301	1,5	250	45	-	10	-	-	-	160 g	10 pcs.
Z 300/45	8035	803501	1,5	300	45	-	12	-	-	-	193 g	10 pcs.
Z 300/35	8036	803601	1,5	300	35	-	-	-	-	6	230 g	10 pcs.
Z 350/50	8037	803701	1,5	350	50	-	14	-	-	-	406 g	10 pcs.
Z 400/35	8038	803801	2,5	400	35	-	-	-	-	8	290 g	10 pcs.
Z 500/35	8039	803901	2,5	500	35	-	-	-	-	10	360 g	10 pcs.

DC01 electrogalvanized

Zawias budowlany ozdobny • Závěs stavební ozdobný • Závěs stavebný ozdobný
 Dekorativna ravna šarka • Dekoratív ládapánt • Şarnieră de constructie decorativă
 Петля строительная декоративная • Декоративна панта за строителството • Bisagra decorativa
 Decorative butt hinge • Charnière de construction décorative • Scharnier dekorativ

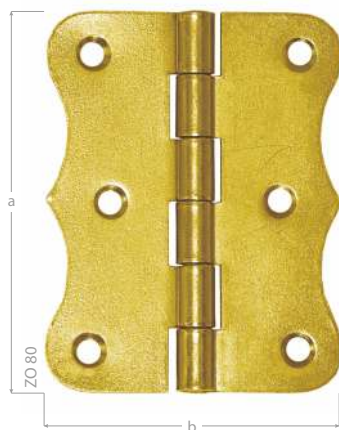

ZO



symbol	art. №		[mm]			qty	ø		
	new	old	≠	a	b				
ZO 80	8046	804601	1,5	80	63	6	75 g	20 pcs.	
ZO 100	8047	804701	2,0	100	105	10	160 g	10 pcs.	

DC01 electrogalvanized





symbol	art. №		[mm]			qty ø			
	new	old	±	a	b	ø4	ø6		
ZF 120	8071	807101	2,5	120	35	6	-	70 g	10 pcs.
ZF 140	8072	807201	2,5	140	35	8	-	80 g	10 pcs.
ZF 160	8073	807301	2,5	160	35	8	-	90 g	10 pcs.
ZF 180	8074	807401	2,5	180	35	8	-	100 g	10 pcs.
ZF 200	8075	807501	2,5	200	33	8	-	110 g	10 pcs.
ZF 250	8076	807601	2,5	250	38	-	10	200 g	10 pcs.
ZF 300	8077	807701	2,5	300	38	-	10	240 g	10 pcs.

DC01 electrogalvanized

Zawias trójkątny splatany • Závěs trojúheln. Splétaný • Záves trojúhol. Splietaný
 Podižuća šarka • Ládapánt • Şarnieră triunghiulară armurată
 Петля треугольная • Шарнирна панта, триъгълна • Bisagra sciente
 Rising hinge • Charnière triangulaire épissée • Deckelscharnier

ZTS



symbol	art. №		[mm]			qty	ø		
	new	old	±	a	b				
ZTS 150	8085	808501	2,0	150	35	6	75 g	10 pcs.	
ZTS 250	8087	808701	2,0	250	45	10	140 g	10 pcs.	
ZTS 200	8088	808801	2,0	200	40	6	140 g	10 pcs.	



DC01 electrogalvanized

4.05

ZTS

Zawias francuski ozdobny • Závěs francouzský ozdobný černý • Závěs francúzky ozdobný čierny
 Dekorativna francuska šarka • Francia zsanér • Şarnieră franceza decorativă
 Петля французская деокративная • Декоративна панта френски тип • Bisagra decorativa francesa
 Decorative french hinge • Charnière française décorative • Französisches Kistenband dekorativ



symbol	art. №		[mm]			qty ø			
	new	old	≠	a	b	ø4,5	ø5		
ZTSD 150	89322	893221	2	150	35	6	-	70 g	10 pcs.
ZFD 200	89452	894521	2	200	40	-	6	116 g	10 pcs.

DC01 powder coating

4.06

ZTSD
ZFD

Zawias trójkątny ozdobny • Závěs trojúhelníkový ozdobný • Závés trijuholníkový ozdobný

Dekoratívna T šarka • Dekoratív zsanér • Şarnieră triunghiulară decorativă

Петля треугольная декоративная • Декоративна панта с триъгълно рамо • Bisagra triangular decorativa

Decorative tee hinge • Charnière triangulaire décorative • Kreuzgehänge dekorativ

ZBD

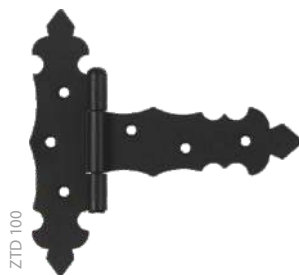

symbol	art. №		[mm]				qty ø				🧴	📦
	new	old	≠	a	b	c	ø4,5	ø6,5	ø7	ø9		
ZTO 125	89202	892001	2,5	125	40	160	-	8	-	-	220 g	10 pcs.
ZTO 150	89212	892101	2,5	150	45	185	-	8	-	-	280 g	10 pcs.
ZTO 200	89222	892201	2,5	200	50	190	-	-	-	6	340 g	10 pcs.
ZTD 100	89262	892621	2,0	100	30	130	6	-	-	-	120 g	10 pcs.
ZTD 150	89282	892821	2,0	150	35	160	7	-	-	-	180 g	10 pcs.
ZBD 200	89362	893621	3,0	200	45	170	-	5	3	-	360 g	10 pcs.
ZBD 300	89382	893821	3,0	300	45	170	-	6	3	-	491 g	10 pcs.
ZBD 400	89402	894021	3,0	400	45	170	-	6	3	-	534 g	10 pcs.

DC01 powder coating

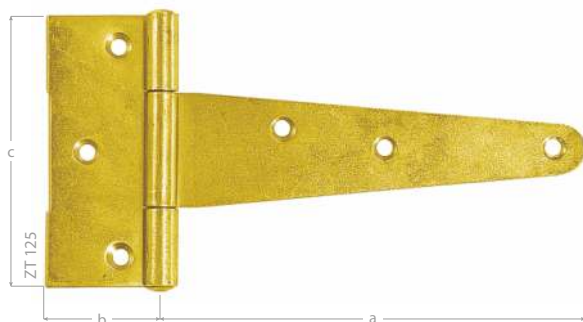

symbol	art. №		≠	[mm]			qty ø		🧴	📦
	new	old		a	b	c	ø4	ø6		
ZT 100	8181	818101	2,0	100	30	65	6	-	80 g	10 pcs.
ZT 125	8182	818201	2,0	125	35	80	6	-	120 g	10 pcs.
ZT 150	8183	818301	2,0	150	35	80	7	-	143 g	10 pcs.
ZT 200	8184	818401	2,5	200	50	110	7	-	350 g	10 pcs.
ZT 250	8185	818501	2,5	250	50	110	-	9	375 g	10 pcs.

DC01 electrogalvanized

Zawias bramkowy • Závěs brankový • Závěs bránkový
 Šarka za kariju • Карупánt csuklós • Şarnieră de poartă
 Петля воротная • Панта за врата • Bisagra para verja
 Gate hinge • Charnière de porte • Kreuzgehänge

ZB

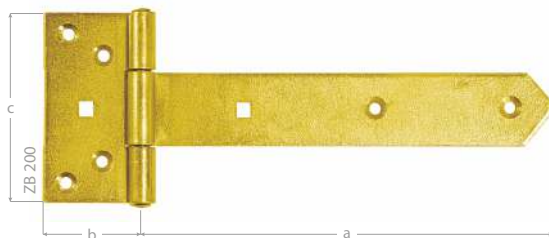

symbol	art. №		[mm]				qty ø				🧴	📦
	new	old	≠	a	b	c	ø6	ø6,5	ø7	ø9		
ZB 150	8101	810101	3	150	45	90	6	-	2	-	270 g	10 pcs.
ZB 200	8102	810201	3	200	45	90	6	-	2	-	310 g	10 pcs.
ZB 250	8103	810301	3	250	45	90	6	-	2	-	370 g	10 pcs.
ZB 300	8104	810401	3	300	45	90	7	-	2	-	400 g	10 pcs.
ZB 350	8105	810501	3	350	45	90	7	-	2	-	430 g	10 pcs.
ZB 400	8106	810601	3	400	45	90	7	-	2	-	500 g	10 pcs.
ZBW 300	8112	811201	4	300	40	110	-	7	-	2	770 g	10 pcs.
ZBW 400	8113	811301	4	400	40	110	-	7	-	2	840 g	10 pcs.
ZBW 500	8114	811401	4	500	40	110	-	7	-	2	1000 g	10 pcs.
ZBW 600	8115	811501	4	600	40	110	-	7	-	2	1100 g	10 pcs.

DC01 electrogalvanized

4.09

ZB
ZBW

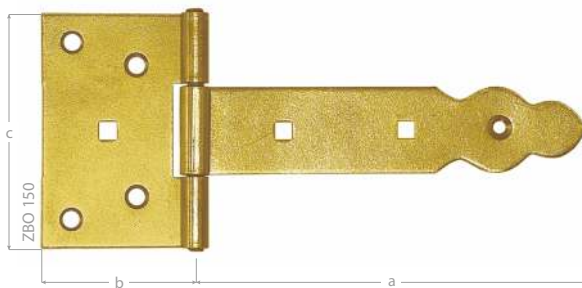

symbol	art. №		≠	[mm]			qty ø			📦	📦
	new	old		a	b	c	ø4	ø6	□7		
ZBO 150	8121	812101	2,5	150	60	90	1	4	3	260 g	10 pcs.
ZBO 250	8122	812201	2,5	250	60	90	2	4	2	330 g	10 pcs.
ZBO 350	8123	812301	2,5	350	60	90	3	4	2	550 g	10 pcs.

DC01 electrogalvanized

Zawias brankowy ozdobny • Závěs brankový ozdobný • Závěs bránkový ozdobný
 Decorativna šarka za kapiju • Dekorativ kapupánt • Şarnieră de poartă decorativă
 Петля воротная декоративная • Декоративна панта за врата • Bisagra decorativa para verja
 Decorative gate hinge • Charnière de porte décorative • Kreuzgehänge dekorativ

ZBNO

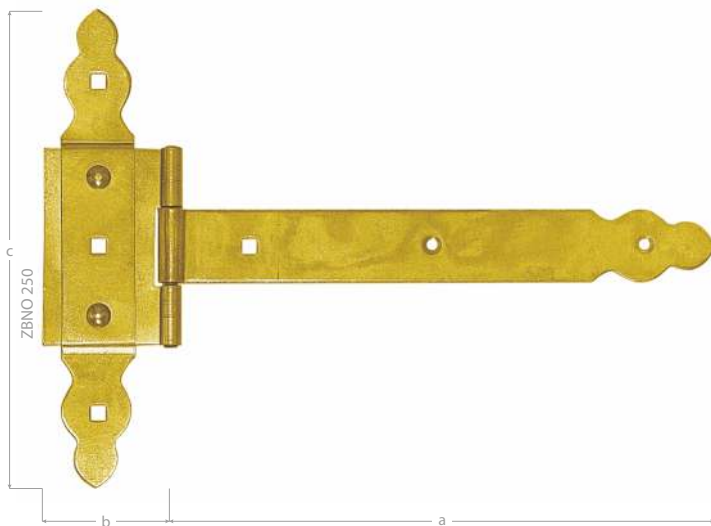

symbol	art. №		≠	[mm]			🧴	📦
	new	old		a	b	c		
ZBNO 150	8141	814101	2,5	150	60	215	360 g	10 pcs.
ZBNO 250	8142	814201	2,5	250	60	215	430 g	10 pcs.
ZBNO 350	8143	814301	2,5	350	60	215	514 g	10 pcs.

DC01 electrogalvanized



symbol	art. №		[mm]				qty ø			🧴	📦
	new	old	≠	a	b	c	ø4	ø5	□7		
ZBL 100	8130	813001	1,5	100	32	65	6	1	-	76 g	10 pcs.
ZBL 150	8131	813101	1,5	150	32	65	6	1	-	91 g	10 pcs.
ZBL 200	8132	813201	2,0	200	38	84	-	6	2	177 g	10 pcs.
ZBL 250	8133	813301	2,0	250	38	84	-	6	2	223 g	10 pcs.
ZBL 300	8134	813401	2,0	300	38	84	-	7	2	254 g	10 pcs.
ZBL 350	8135	813501	2,0	350	38	84	-	7	2	275 g	10 pcs.
ZBL 400	8136	813601	2,0	400	38	84	-	8	2	361 g	10 pcs.
ZBL 450	8137	813701	2,2	450	45	91	-	8	2	443 g	10 pcs.
ZBL 500	8138	813801	1,2	500	45	91	-	9	2	478 g	10 pcs.

DC01 electrogalvanized

Zawias bramkowy pasowy • Závěs brankový pásový • Závěs bránkový pásový
 Šarka za kariju koplje • Карупánt ов csuklós • Šarnieră de poartă ajustată
 Петля воротная • Панта за врата, продълговата • Bisagra fina de verja
 Strap gate hinge • Charnière de porte / penture • Werfgehänge



ZBP

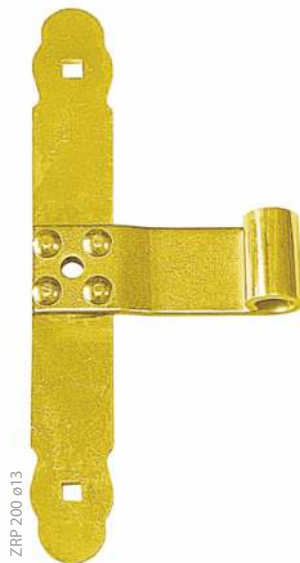
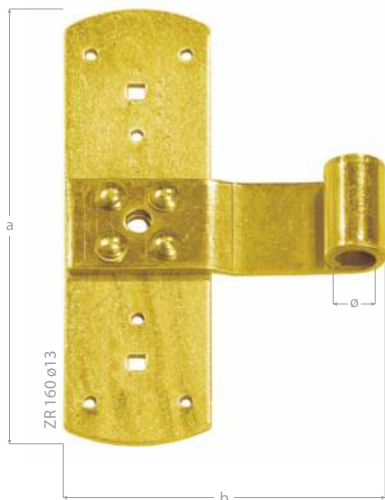

symbol	art. №		≠	[mm]			🔩	📦
	new	old		a	b	c		
ZBP 200	8161	816101	2,5	200	80	50	190 g	10 pcs.
ZBP 250	8162	816201	2,5	250	80	50	215 g	10 pcs.
ZBP 300	8163	816301	2,5	300	80	50	360 g	10 pcs.

DC01 electrogalvanized



symbol	art. №		≠	[mm]		ø		
	new	old		a	b			
ZR 165/13	8261	826101	3,0	165	110	13	340 g	10 pcs.
ZRP 200/13	8265	826501	3,0	200	100	13	330 g	10 pcs.

DC01 electrogalvanized

4.14

Zawias narożnikowy prosty prawy i lewy • Záv. Okenicový jedn. L+P • Záv. Okenicový jedn. L+P
 Ugaone šarke, leva + desna • Sarokpánt alsó-felső bal + jobb • Şarnieră colț simplă dreaptă și stîngă
 Петля угловая, левая + правая • Ъглова панта права, лява и дясна • Bisagra esquinera, izquierdo + derecho
 Corner hinges left + right • Charnière de coin simple, droite et gauche • Fensterladen-Winkelband links + rechts

ZN

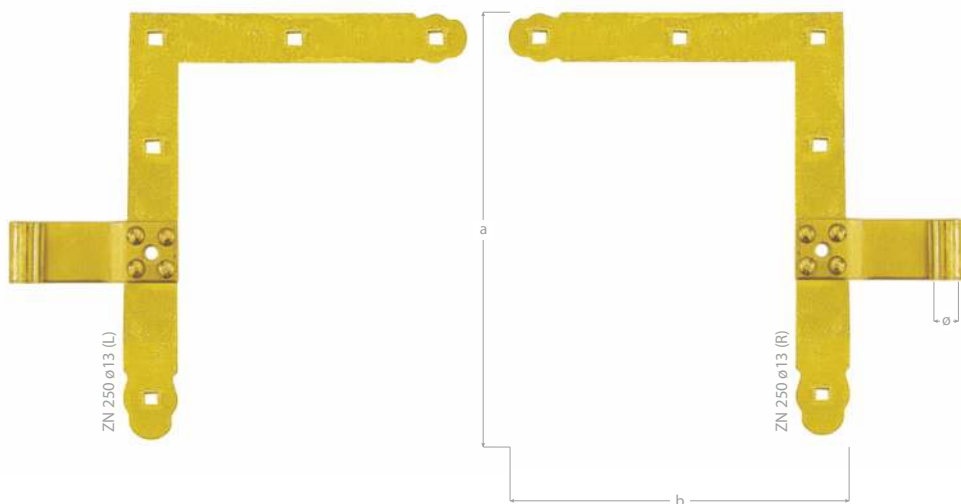

symbol	art. №		≠	[mm]		ø	🧴	📦
	new	old		a	b			
ZN 250/13 L+R	8271	827101	3,0	250	200	13	887 g	5 pcs.

DC01 electrogalvanized



ZP 800 ø16

symbol	art. №		÷	[mm]		ø	🧴	📦
	new	old		a	b			
ZP 300/10	8201	820101	3,0	300	30	10	230 g	10 pcs.
ZP 300/10 C	82012	820131	3,0	300	30	10	230 g	10 pcs.
ZP 400/10	8202	820201	3,0	400	30	10	300 g	10 pcs.
ZP 400/10 C	82022	820231	3,0	400	30	10	300 g	10 pcs.
ZP 300/13	8203	820311	4,0	300	35	13	356 g	10 pcs.
ZP 300/13 C	82032	820331	4,0	300	35	13	356 g	10 pcs.
ZP 400/13	8204	820411	4,0	400	35	13	468 g	10 pcs.
ZP 400/13 C	82042	820431	4,0	400	35	13	468 g	10 pcs.
ZP 500/13	8205	820511	4,0	500	35	13	572 g	10 pcs.
ZP 500/13 C	82052	820531	4,0	500	35	13	572 g	10 pcs.
ZP 600/13	8206	820611	4,0	600	35	13	689 g	10 pcs.
ZP 600/13 C	82062	820631	4,0	600	35	13	689 g	10 pcs.
ZP 500/16	8207	820711	5,0	500	40	16	764 g	10 pcs.
ZP 500/16 C	82072	820731	5,0	500	40	16	828 g	10 pcs.
ZP 600/16	8208	820811	5,0	600	40	16	986 g	10 pcs.
ZP 600/16 C	82082	820831	5,0	600	40	16	986 g	10 pcs.
ZP 800/16	8209	820911	5,0	800	40	16	1238 g	10 pcs.
ZP 800/16 C	82092	820931	5,0	800	40	16	1238 g	10 pcs.
ZP 1000/16	8210	821011	5,0	1000	40	16	1546 g	6 pcs.
ZP 1200/16	8211	821111	5,0	1200	40	16	1830 g	6 pcs.

DC01 electrogalvanized

Uchwyt czopowy • Držák čepu • Držiak čapu
 Nosač šarke • Pántcsap • Míner de pivot
 Ответная часть петли • Държач с цапфа • Soporte de bisagra
 Hinge pin • Fiche de la charnière • Kloben

C

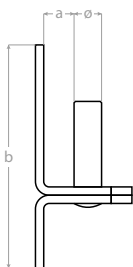
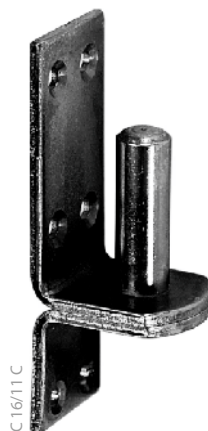

symbol	art. №		±	[mm]		ø	🧴	📦
	new	old		a	b			
C 10/11	8301	830101	3,0	11	81	10	110 g	10 pcs.
C 10/11 C	83012	830131	3,0	11	81	10	111 g	10 pcs.
C 10/25	8302	830201	3,0	25	86	10	131 g	10 pcs.
C 10/25 C	83022	830231	3,0	25	86	10	132 g	10 pcs.
C 13/11	8303	830311	4,0	11	104	13	216 g	10 pcs.
C 13/11 C	83032	830331	4,0	11	104	13	216 g	10 pcs.
C 13/25	8304	830411	4,0	25	103	13	246 g	10 pcs.
C 13/25 C	83042	830431	4,0	25	103	13	248 g	10 pcs.
C 16/11	8305	830511	4,0	11	120	16	281 g	10 pcs.
C 16/11 C	83052	830531	4,0	11	120	16	310 g	10 pcs.
C 16/25	8306	830611	4,0	25	130	16	340 g	10 pcs.
C 16/25 C	83062	830631	4,0	25	130	16	344 g	10 pcs.

DC01 electrogalvanized

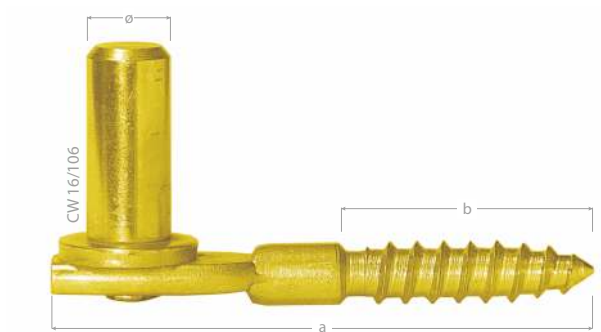



symbol	art. №		[mm]			📦	📦
	new	old	a	b	ø		
CW 16/106	8307	830701	106	48	16	145 g	10 pcs.
CW 13/106	8308	830801	106	48	13	145 g	10 pcs.
CW 10/106	8309	830901	106	48	10	145 g	10 pcs.

DC01 electrogalvanized

Uchwyt czopowy do muru • Drľák ěepu do zdiva • DrŹiak ěapu do muriva
 Nosaĉ ťarke za beton • Pántcsap betonozható • Míner de pivot pe perete
 Ответная часть петли • Държач с цапфа за стена • Soporte de bisagra para hormigón
 Concrete-in hinge pin • Fiche de la charnière contre le mur • Kloben zum Eingipsen



CM



symbol	art. №		≠	[mm]		ø		
	new	old		a	b			
CM 13	8343	834301	5	255	40	13	440 g	10 pcs.
CM 16	8345	834501	6	255	44	16	575 g	10 pcs.

DC01 electrogalvanized





symbol	art. №		≠	[mm]		c		
	new	old		a	b			
ZZBR 150	8711	871101	2,5	100	50	100	255 g	10 pcs.

DC01 electrogalvanized

Zawias z zamknięciem bramkowy pasowy • Závěs zamykací brankový pásový • Závěs zamykací bránkový pásový
 Šarka za kapiju koplje sa rezom • Csuklós lakatpánt díszes • Şarnieră cu închidere de poartă ajustată
 Петля поясная с запором • Панта за врата с ключалка, продълговата • Bisagra fina con cerradura
 Strap gate hinge with lock • Charnière avec fermeture, penture • Sicherheitsüberfalle



ZZB

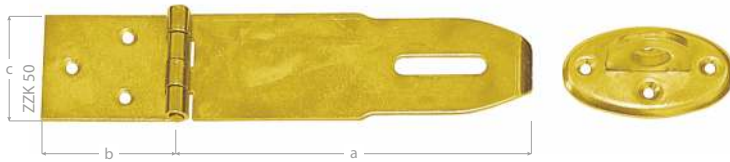

symbol	art. №		≠	[mm]		c		
	new	old		a	b			
ZZB 200	8731	873101	2,5	200	95	35	200 g	10 pcs.
ZZB 250	8732	873201	2,5	250	95	35	250 g	10 pcs.
ZZB 300	8733	873301	2,5	300	95	35	270 g	10 pcs.

DC01 electrogalvanized



symbol	art. №		≠	[mm]				
	new	old		a	b	c		
ZZK 50	8751	875101	2,0	130	50	45	160 g	10 pcs.
ZZK 75	8753	875301	2,0	175	75	55	350 g	10 pcs.

DC01 electrogalvanized

Zawias z zamknięciem prosty • Závěs zamykací jednoduchý • Záves zamykací bránkový jedn.
 Šarka sa podloškom i nosačem, prava • Csuklós lakatpánt díszes, egyenes • Šarnieră cu închidere simplă
 Петля с затвором, прямая • Панта с ключалка, права • Bisagra con cerradura, recta
 Hinge with padlock bracket, straight • Charnière avec fermeture, simple • Sicherheitsüberfalle

ZZP



symbol	art. №		≠	[mm]			🧴	📦
	new	old		a	b	c		
ZZP 25	8721	872101	1,5	75	25	25	34 g	10 pcs.
ZZP 50	8722	872201	1,5	90	50	45	90 g	10 pcs.
ZZP 80	8723	872301	1,5	90	80	45	105 g	10 pcs.
ZZP 200	8724	872401	2,5	90	200	35	210 g	10 pcs.

DC01 electrogalvanized





symbol	art. №		[mm]		🧴	📦
	new	old	a	d		
ZRS 16	8420	842011	50	M16	300 g	6 pcs.
ZRS 20	8422	842211	68	M20	504 g	6 pcs.

DC01 electrogalvanized

Zawias regulowany do przykręcania • Závěs stavitelný k přišroubování • Závěs nastavitelný ,na prišróbovanie
 Podesiva šarkasa platnom • Pánt állítható és lemezzel • Şarnieră reglabilă pentru fixare
 Петля для прикручивания • Регулируема панта за завинтване • Bisagra ajustable con base
 Patrz niżej • Charnière réglable à visser • Regulierbares Scharnier zum Anschrauben

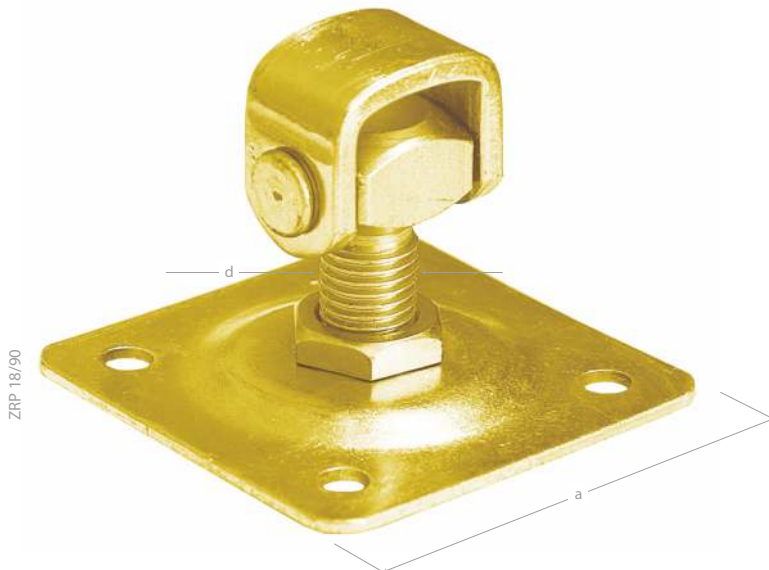

ZRDP

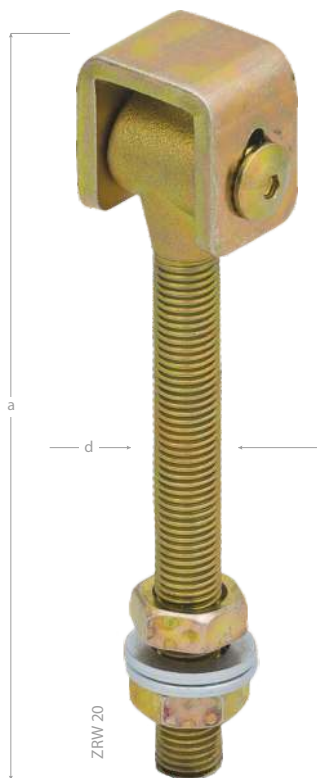

symbol	art. №		[mm]			
	new	old	a	d		
ZRDP 16/80	8421	842111	80	M16	531 g	6 pcs.
ZRDP 18/90	8424	842411	90	M18	628 g	6 pcs.
ZRDP 20/100	8423	842311	100	M20	712 g	6 pcs.

DC01 electrogalvanized





symbol	art. №		[mm]			
	new	old	a	d		
ZRW 16	8427	842691	170	M16	610 g	6 pcs.
ZRW 20	8426	842601	170	M20	740 g	6 pcs.

DC01 electrogalvanized

Zawias regulowany do muru • Závěs stavitelný do zdi • Závěs nastavitelný do muriva
 Podesiva šarka za beton • Pánt betonzható és állítható • Şarniërã reglabilã pe perete
 Петля регулируемая (стенная) • Регулируема панта за зидана стена • Gozne ajustable para hormigón
 Concrete - in adjustable hinge • Charnière réglable contre le mur • Mauerscharnier, einstellbar

ZRM



symbol	art. N°		[mm]		 560 g	 2 pcs.
	new	old	a	d		
ZRM 20	8425	842501	160	M20		

DC01 electrogalvanized

Zasuwa z rygłem płaskim prosta • Zástrč jednoduchá • Zástrč jednoduchá
 Reza za vrata • Tolózár egyenes gombos • Zăvor simplu cu închizător plat
 Задвижка • Право резе с плосък райбер • Pasador recto
 Door bolt, straight • Verrou de porte simple • Türriegel mit Knopf und Schlaufe

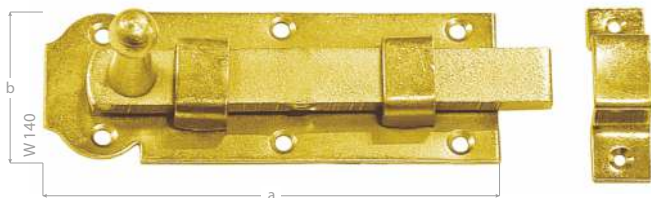

symbol	art. №		[mm]		🔑	📦
	new	old	a	b		
W 80	8501	850101	80	30	50 g	10 pcs.
W 100	8502	850201	100	45	190 g	10 pcs.
W 120	8503	850301	120	45	220 g	10 pcs.
W 140	8504	850401	140	55	250 g	10 pcs.
W 160	8505	850501	160	55	290 g	10 pcs.
W 180	8506	850601	180	65	450 g	10 pcs.
WP 160	8507	850701	160	65	440 g	10 pcs.

DC01 electrogalvanized

Zasuwa zamykana tłoczona z rygłem prostym • Zástrč lisovaná zamykací jednod. • Zástrč lisovaná jednoduchá
 Boks reza • Tolózár lakatolható • Závor presat cu închizător simplu
 Задвижка штампованная • Заключващо се резе, щамповано, с прав райбер • Pasador
 Box bolt • Verrou de fermeture tourné, simple • Schlossriegel mit flachem Griff und Schlaufe

WZTW



symbol	art. №		[mm]		🔑	📦
	new	old	a	b		
WZTW 80	8551	855101	80	40	50 g	20 pcs.
WZTW 100	8552	855201	100	40	71 g	20 pcs.
WZTW 120	8553	855301	120	45	116 g	20 pcs.

DC01 electrogalvanized

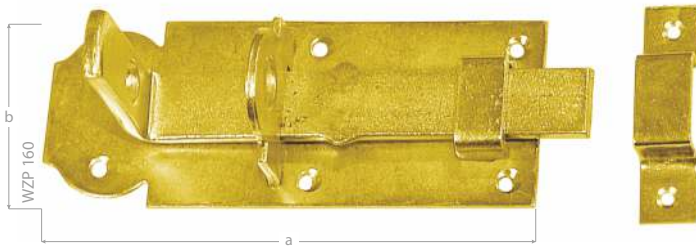

symbol	art. №		[mm]		🔑	📦
	new	old	a	b		
WZP 80 bez otworu / without hole for padlock	8531	853101	80	30	55 g	10 pcs.
WZP 100	8532	853201	100	45	160 g	10 pcs.
WZP 120	8533	853301	120	45	180 g	10 pcs.
WZP 140	8534	853401	140	55	240 g	10 pcs.
WZP 160	8535	853501	160	55	310 g	10 pcs.
WZP 180	8536	853601	180	65	330 g	10 pcs.

DC01 electrogalvanized

Zasuwa zamykana z rygłem wygiętym • Zástrč zamykací typu z • Zástrč zamykacia "z"
 Reza za zatvaranje vrata, savijena • Zárható tolózár, hajlított • Zavor cu închizător curbat
 Задвижка запорная загнутая • Заключаюча се резе с извит райбер • Pasador plegado
 Closing door bolt, folded • Verrou de fermeture plié • Schlossriegel mit flachem Griff und Schließblech

WZW

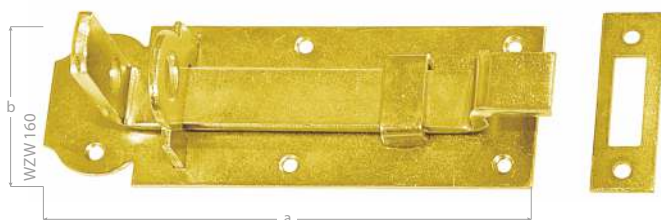

symbol	art. №		[mm]		🧴	📦
	new	old	a	b		
WZW 120	8543	854301	120	45	220 g	10 pcs.
WZW 140	8544	854401	140	55	280 g	10 pcs.
WZW 160	8545	854501	160	55	310 g	10 pcs.
WZW 180	8546	854601	180	65	340 g	10 pcs.

DC01 electrogalvanized

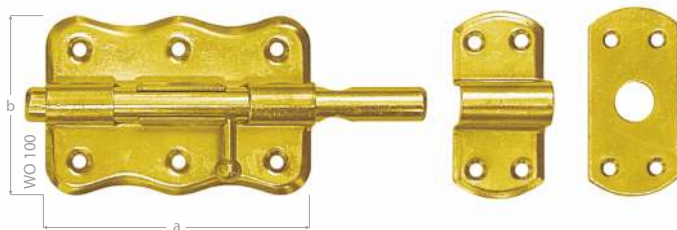

symbol	art. №		[mm]		🔩	📦
	new	old	a	b		
WRO 50	8561	856101	50	50	84 g	10 pcs.
WRO 70	8562	856201	70	50	109 g	10 pcs.
WRO 100	8563	856301	100	65	303 g	10 pcs.
WRO 120	8564	856401	120	68	391 g	10 pcs.
WRO 200	8567	856701	200	80	930 g	10 pcs.

DC01 electrogalvanized

Zasuwa z rygłem okrągłym wąska • Zástrč s kulatým jezdcem úzka • Zástrč s guľatým jazdcom úzka
 Dekorativna reza, tanka • Bajonett tolózár díszes, vékony • Zävor ïngust cu ïnchizätor rotund
 Задвижка с круглым ригелем • Резе с кръгъл райбер, тясно • Pestillo decorativo, fino
 Decorative tower bolt, thin • Verrou rond étroit • Grendelriegel mit Knopf

WOS



symbol	art. N ^o		[mm]			
	new	old	a	b		
WOS 70	8572	857201	70	10	80 g	10 pcs.

DC01 electrogalvanized

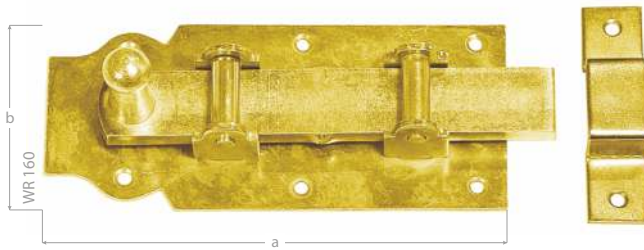

symbol	art. №		[mm]			
	new	old	a	b		
WR 160	8591	859101	160	70	550 g	5 pcs.

DC01 electrogalvanized

Zasuwa ogrodowa • Závora zahradní • Závora záhradná
 Baštenska reza • Kertajtózár • Závor de grădină
 Задвижка огородная • Градинско резе • Pasador de jardín
 Garden bolt • Verrou de jardin • Gartentorfalle

WOG



symbol	art. №		[mm]			
	new	old	a	b		
WOG 80	8612	861201	80	60	310 g	5 pcs.

DC01 electrogalvanized

4.35

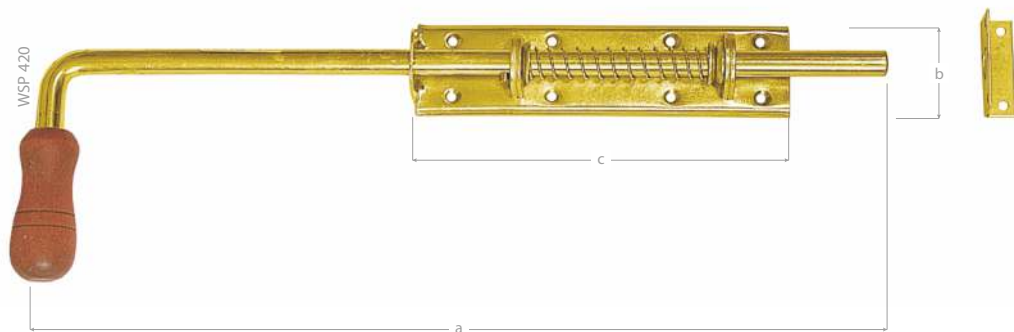

symbol	art. №		[mm]			🧴	📦
	new	old	a	b	c		
WSP 150	8620	862011	150	50	100	220 g	10 pcs.
WSP 260	8621	862101	260	50	190	610 g	10 pcs.
WSP 420	8623	862301	420	50	190	740 g	10 pcs.
WSP 600	8625	862511	600	50	190	960 g	5 pcs.

DC01 electrogalvanized

Zasuwa ryglowa z rączką drewnianą • Zástrč zasouvací • Zástrč zasúvacia
 Vučna reza sa drvenom drškom • Kaputolózár • Závör cu manetă din lemn
 Задвижка воротная пружинная • Резе с райбер с дървена дръжка • Pasador de torre
 Tower bolt • Verrou avec manchon en bois • Riegel mit Holzhebel

WRG

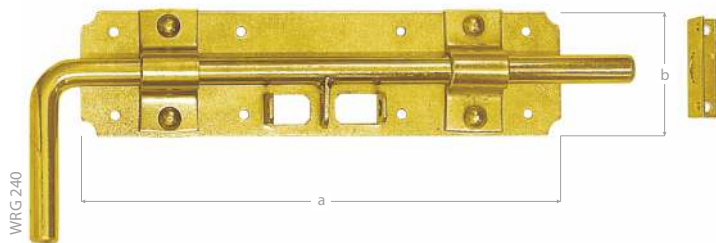
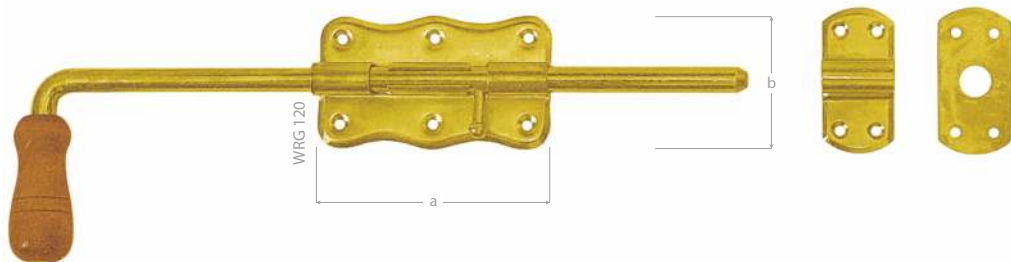

symbol	art. №		[mm]		🧴	📦
	new	old	a	b		
WRG 120	8624	862401	120	60	450 g	10 pcs.
WRG 240	8632	863201	240	60	760 g	10 pcs.

DC01 electrogalvanized

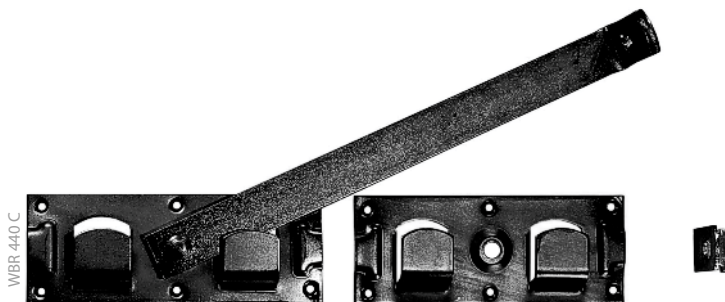
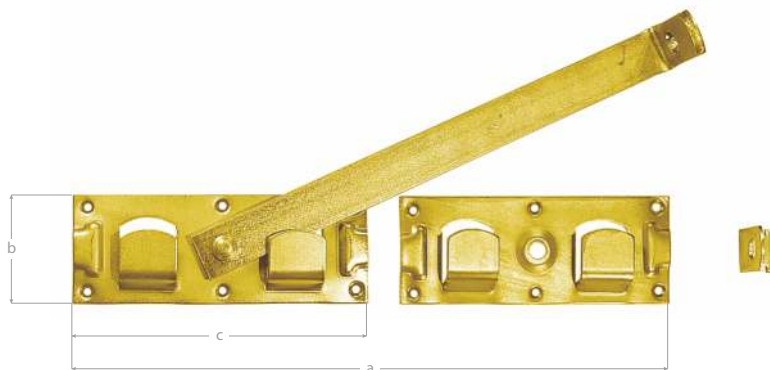



symbol	art. №		a	[mm]			📦	📦
	new	old		b	c			
WBR 440	8641	864111	max 440	70	180	1220 g	5 pcs.	
WBR 440 C	86412	864131	max 440	70	180	1220 g	5 pcs.	

DC01 electrogalvanized

Zasuwa ciężka • Závora těžká • Závora pevná
 Teška reza dekorativna • Erősített bajonett tolózár lakatolható • Závor greu
 Петля тяжелая • Тежко резе • Pasador duro
 Heavy duty tower bolt • Verrou lourd • Bolzenriegel schwer mit befestigter Schlaufe

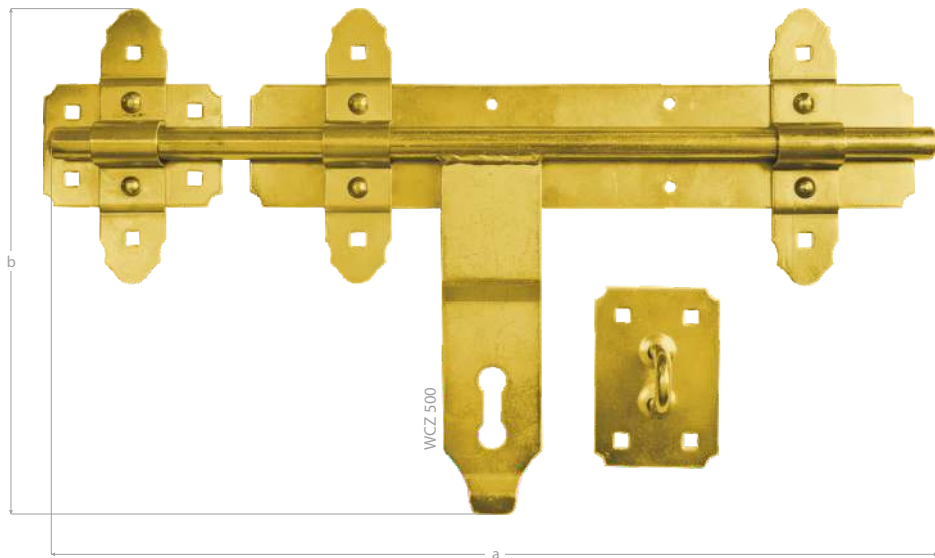
WCZ



symbol	art. №		[mm]			
	new	old	a	b		
WCZ 150	8651	865111	200	200	800 g	5 pcs.
WCZ 150 C	86512	865131	200	200	800 g	5 pcs.
WCZ 250	8652	865201	250	200	900 g	2 pcs.
WCZ 300	8653	865301	300	200	1048 g	2 pcs.
WCZ 350	8654	865401	350	200	1167 g	2 pcs.
WCZ 500	8655	865501	500	200	2241 g	2 pcs.

DC01 electrogalvanized

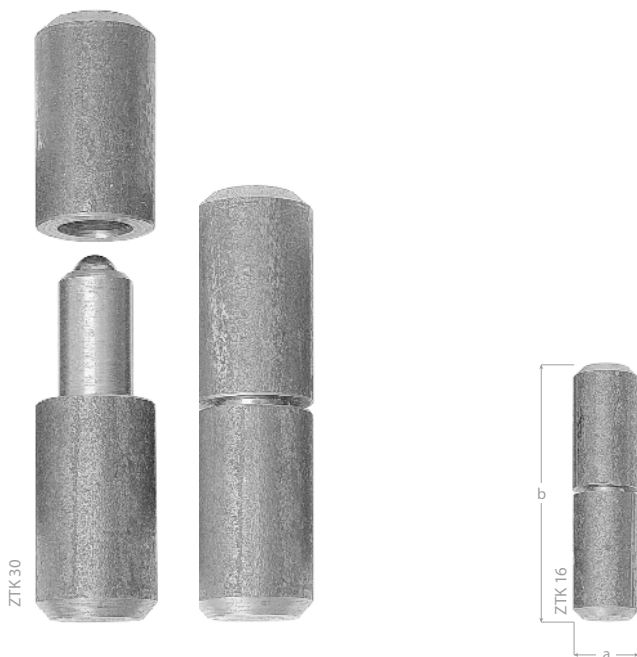



symbol	art. №		[mm]		🍷	📦
	new	old	a	b		
ZTK 16	8402	840201	16	65	100 g	10 pcs.
ZTK 18	8403	840301	18	70	150 g	10 pcs.
ZTK 20	8404	840401	20	80	210 g	10 pcs.
ZTK 22	8405	840501	22	90	260 g	10 pcs.
ZTK 25	8406	840601	25	100	380 g	10 pcs.
ZTK 27	8407	840701	27	110	580 g	10 pcs.
ZTK 30	8408	840801	30	110	600 g	10 pcs.
ZTK 35	8409	840901	35	130	970 g	10 pcs.

Narożnik skrzyniowy • Rohovník bedňový • Rohovník bedňový
 Ugaonik za kovčeg • Ládasarok • Colț cutie
 Наугольник • Ъгълник за сандък • Protector de esquinas
 Chest corner • Coin du coffre • Kistenecke

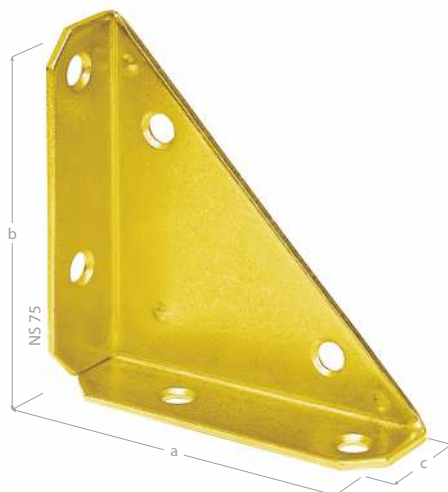
NS



symbol	art. №		≠	[mm]				
	new	old		a	b	c		
NS 50	8833	883301	1,5	50	50	16	30 g	10 pcs.
NS 75	8834	883401	2	75	75	20	86 g	10 pcs.
NS 100	8835	883501	2	100	100	28	165 g	10 pcs.

DC01 electrogalvanized





symbol	art. №		[mm]			
	new	old	a	b		
ZSK 70	8760	876001	70	7	120 g	20 pcs.

DC01 electrogalvanized

Haczyk zamykający wkręcany • Háček s očkem k zašroubování • Háčik s očkom na šrobovanie
 Zakačka sa kukom • Кампó зър • Cirligaș de închidere de înșurubat
 Крючок • Кука за затваряне, за завинтване • Cerradura de gancho
 Hook lock • Crochet de blocage vissé • Sturmhaken mit Öse

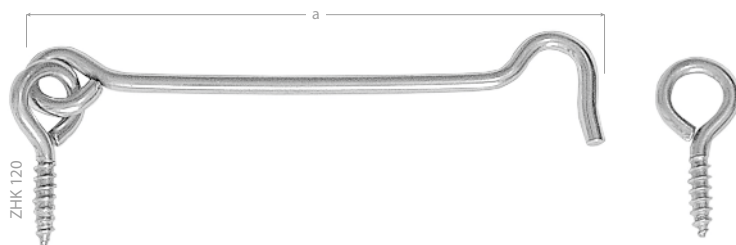

ZHK



symbol	art. №		[mm] a		
	new	old			
ZHK 60	8871	887111	60	17 g	50 pcs.
ZHK 80	8872	887211	80	21 g	50 pcs.
ZHK 100	8873	887311	100	42 g	50 pcs.
ZHK 120	8874	887411	120	46 g	50 pcs.

DC01 electrogalvanized



symbol	art. №		[mm]			
	new	old	a	b		
US 90	8831	883101	90	70	140 g	10 pcs.
US 115	8832	883201	115	80	202 g	10 pcs.

DC01 electrogalvanized

Uchwyt • Opláštená konzola • Opláštená konzola
 Ručka • Kerítés konzol • Míner
 Ручка • Приспособление за захващане • Soporte para valla
 Fence bracket • Attache • Torgriff

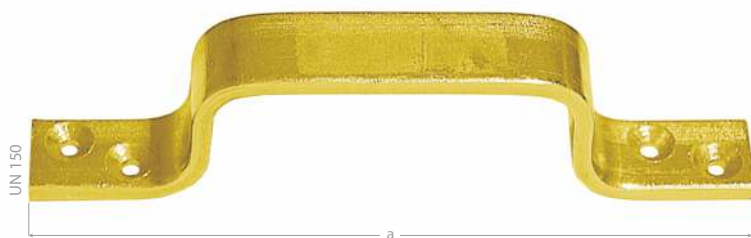

UN



symbol	art. №		[mm]			
	new	old	≠	a		
UN 150	8840	884001	4,0	150	120 g	10 pcs.

DC01 electrogalvanized



symbol	art. №		[mm]			
	new	old	a	ø		
ST 250	8821	882101	250	14	140 g	10 pcs.
ST 350	8822	882201	350	25	400 g	2 pcs.

DC01 electrogalvanized



WKRETY CIESIELSKIE

TESAŘSKÝ VRUT

VRUTY TESÁRSKE

ŠRAFOVI ZA DRVO

FAFORGÁCSLAP CSAVAR

HOLT-SURUBURI DE DULGHERIE

ШУРУПЫ ПО ДЕРЕВУ

ДЪРВОДЕЛСКИ ВИНТОВЕ

TORNILLO PARA AGLOMERADO

CHIPBOARD SCREW

VIS À PANNEAU D'AGGLOMÉRÉ

HOLZBAUSCHRAUBEN

dmxsystem.com



Wkręt ciesielski z łbem stożkowym • Tesarşky vrut se zapuřtenou hlavou • Tesarşky vrut zo zapuřtenou hlavou
 řraf za drvo sa ravnom glavom • Faszerkezeti csavar sũlyeszett fejũ • Holt-şurub de dulgherie cu cap conic
 Şurup samonarezauşyũy dla dera va potay • Dũrvodelski bolt sũs skrita glava • Tornillo para aglomerado de cabeza plana
 Chipboard screw with flat head • Vis pour panneau d'aggloméré à tête plate • Holzbauschraube - Senkkopf

CS

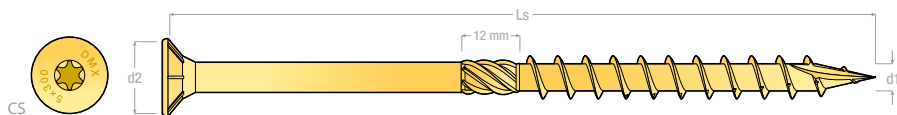
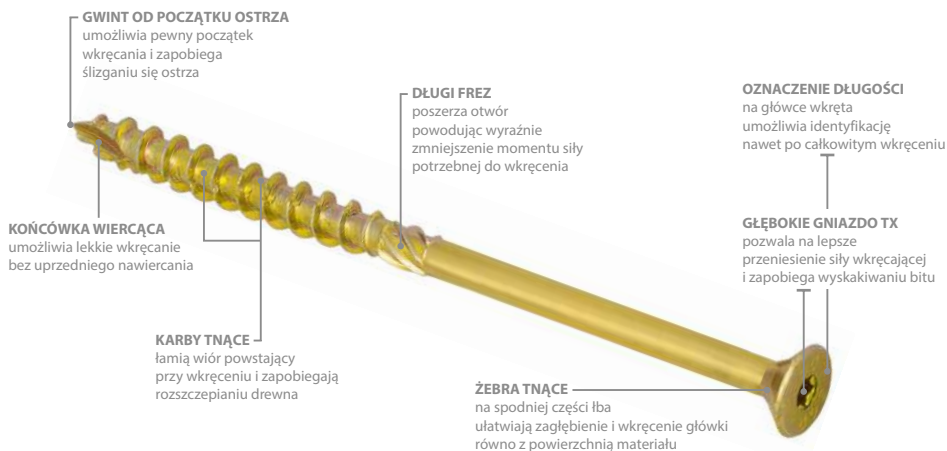



symbol	art. №		d1	[mm]		TORX		
	new	old		d2	Ls			
CS 05040	310503	310503	5	10	40	T25	3,40 g	200 pcs.
CS 05045	310504	310504	5	10	45	T25	3,80 g	200 pcs.
CS 05050	310505	310505	5	10	50	T25	4,10 g	200 pcs.
CS 05060	310506	310506	5	10	60	T25	4,84 g	200 pcs.
CS 05070	310507	310507	5	10	70	T25	5,48 g	200 pcs.
CS 05080	310508	310508	5	10	80	T25	6,26 g	200 pcs.
CS 05090	310509	310509	5	10	90	T25	7,03 g	100 pcs.
CS 05100	310510	310510	5	10	100	T25	7,83 g	100 pcs.
CS 05120	310512	310512	5	10	120	T25	9,19 g	100 pcs.
CS 06070	310607	310607	6	12	70	T30	8,43 g	200 pcs.
CS 06080	310608	310608	6	12	80	T30	9,48 g	200 pcs.
CS 06100	310610	310610	6	12	100	T30	11,78 g	100 pcs.
CS 06120	310612	310612	6	12	120	T30	13,88 g	100 pcs.

C10B21

NEW

5.01

CS

symbol	art. №		d1	[mm]		TORX		
	new	old		d2	Ls			
CS 06140	310614	310614	6	12	140	T30	16,00 g	100 pcs.
CS 06160	310616	310616	6	12	160	T30	18,22 g	100 pcs.
CS 06180	310618	310618	6	12	180	T30	20,63 g	100 pcs.
CS 06200	310620	310620	6	12	200	T30	23,02 g	100 pcs.
CS 06220	310622	310622	6	12	220	T30	25,14 g	100 pcs.
CS 06240	310624	310624	6	12	240	T30	27,26 g	100 pcs.
CS 06260	310626	310626	6	12	260	T30	29,66 g	100 pcs.
CS 06280	310628	310628	6	12	280	T30	31,68 g	100 pcs.
CS 06300	310630	310630	6	12	300	T30	34,00 g	100 pcs.
CS 08080	310808	310808	8	15	80	T40	18,21 g	100 pcs.
CS 08100	310810	310810	8	15	100	T40	22,40 g	100 pcs.
CS 08120	310812	310812	8	15	120	T40	26,56 g	100 pcs.
CS 08140	310814	310814	8	15	140	T40	31,36 g	100 pcs.
CS 08160	310816	310816	8	15	160	T40	35,48 g	100 pcs.
CS 08180	310818	310818	8	15	180	T40	39,60 g	100 pcs.
CS 08200	310820	310820	8	15	200	T40	43,72 g	100 pcs.
CS 08220	310822	310822	8	15	220	T40	47,84 g	100 pcs.
CS 08240	310824	310824	8	15	240	T40	51,96 g	100 pcs.
CS 08260	310826	310826	8	15	260	T40	56,08 g	100 pcs.
CS 08280	310828	310828	8	15	280	T40	60,20 g	100 pcs.
CS 08300	310830	310830	8	15	300	T40	64,32 g	100 pcs.
CS 08320	310832	310832	8	15	320	T40	68,44 g	50 pcs.
CS 08340	310834	310834	8	15	340	T40	72,56 g	50 pcs.
CS 08360	310836	310836	8	15	360	T40	76,67 g	50 pcs.
CS 08380	310838	310838	8	15	380	T40	80,79 g	50 pcs.
CS 08400	310840	310840	8	15	400	T40	84,91 g	50 pcs.
CS 10120	311012	311012	10	18	120	T40	39,94 g	50 pcs.
CS 10140	311014	311014	10	18	140	T40	46,28 g	50 pcs.
CS 10160	311016	311016	10	18	160	T40	51,96 g	50 pcs.
CS 10180	311018	311018	10	18	180	T40	58,78 g	50 pcs.
CS 10200	311020	311020	10	18	200	T40	64,48 g	50 pcs.
CS 10220	311022	311022	10	18	220	T40	69,24 g	50 pcs.
CS 10240	311024	311024	10	18	240	T40	76,10 g	50 pcs.
CS 10260	311026	311026	10	18	260	T40	82,88 g	50 pcs.
CS 10280	311028	311028	10	18	280	T40	87,68 g	50 pcs.
CS 10300	311030	311030	10	18	300	T40	93,92 g	50 pcs.
CS 10320	311032	311032	10	18	320	T40	100,38 g	50 pcs.
CS 10340	311034	311034	10	18	340	T40	107,08 g	50 pcs.
CS 10360	311036	311036	10	18	360	T40	110,38 g	50 pcs.
CS 10380	311038	311038	10	18	380	T40	119,30 g	50 pcs.
CS 10400	311040	311040	10	18	400	T40	124,18 g	50 pcs.

C10B21

NEW

5.02

Wkręt ciesielski z łbem talerzowym • Tesárský vrut s talírovou hlavou • Tesárský vrut s tanierovou hlavou
 Šraf za drvo sa oblom glavom • Faszkerkezeti csavar tányérféjű • Holz-şurub de dulgherie cu cap în formă de disc
 Шуруп самонарезающий для дерева прессшайба • Дърводелски болт с цилиндрична глава с кръстат шлиц • Tornillo para aglomerado de cabeza wafer
 Chipboard screw with wafer head • Vis pour panneau d'aggloméré à tête mince • Holzbauschraube - Tellerkopf

CT

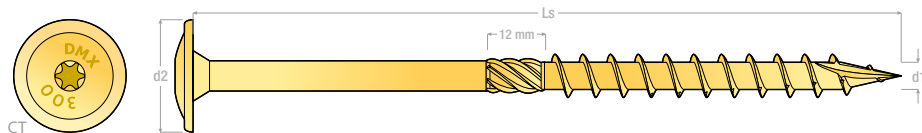

symbol	art. №		d1	[mm]		TORX	🧴	📦
	new	old		d2	Ls			
CT 08080	320808	320808	8	23	80	T40	22,51 g	50 pcs.
CT 08100	320810	320810	8	23	100	T40	26,63 g	50 pcs.
CT 08120	320812	320812	8	23	120	T40	30,74 g	50 pcs.
CT 08140	320814	320814	8	23	140	T40	34,86 g	50 pcs.
CT 08160	320816	320816	8	23	160	T40	38,98 g	50 pcs.
CT 08180	320818	320818	8	23	180	T40	43,10 g	50 pcs.
CT 08200	320820	320820	8	23	200	T40	47,22 g	50 pcs.
CT 08220	320822	320822	8	23	220	T40	51,34 g	50 pcs.
CT 08240	320824	320824	8	23	240	T40	55,46 g	50 pcs.
CT 08260	320826	320826	8	23	260	T40	59,58 g	50 pcs.
CT 08280	320828	320828	8	23	280	T40	63,70 g	50 pcs.
CT 08300	320830	320830	8	23	300	T40	67,82 g	50 pcs.
CT 08320	320832	320832	8	23	320	T40	71,94 g	50 pcs.
CT 08340	320834	320834	8	23	340	T40	76,06 g	50 pcs.
CT 08360	320836	320836	8	23	360	T40	80,18 g	50 pcs.
CT 08380	320838	320838	8	23	380	T40	84,29 g	50 pcs.
CT 08400	320840	320840	8	23	400	T40	88,41 g	50 pcs.
CT 10120	321012	321012	10	26	120	T40	44,68 g	50 pcs.
CT 10140	321014	321014	10	26	140	T40	50,72 g	50 pcs.
CT 10160	321016	321016	10	26	160	T40	56,77 g	50 pcs.
CT 10180	321018	321018	10	26	180	T40	62,81 g	50 pcs.
CT 10200	321020	321020	10	26	200	T40	68,85 g	50 pcs.
CT 10220	321022	321022	10	26	220	T40	74,89 g	50 pcs.
CT 10240	321024	321024	10	26	240	T40	80,93 g	50 pcs.
CT 10260	321026	321026	10	26	260	T40	86,97 g	50 pcs.
CT 10280	321028	321028	10	26	280	T40	93,02 g	50 pcs.
CT 10300	321030	321030	10	26	300	T40	99,06 g	25 pcs.
CT 10320	321032	321032	10	26	320	T40	105,10 g	25 pcs.
CT 10340	321034	321034	10	26	340	T40	111,14 g	25 pcs.
CT 10360	321036	321036	10	26	360	T40	117,18 g	25 pcs.
CT 10380	321038	321038	10	26	380	T40	123,22 g	25 pcs.
CT 10400	321040	321040	10	26	400	T40	129,27 g	25 pcs.

C10B21

NEW

5.03

CT

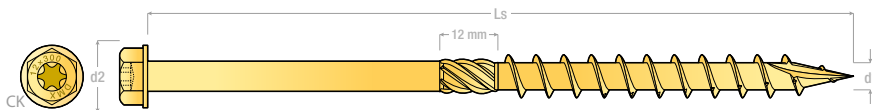

symbol	art. №		[mm]			TORX	🍷	📦
	new	old	d1	d2	Ls			
CK 08140	330814	330814	8	15	140	T40	31,84 g	100 pcs.
CK 08160	330816	330816	8	15	160	T40	36,20 g	100 pcs.
CK 08180	330818	330818	8	15	180	T40	40,40 g	100 pcs.
CK 08200	330820	330820	8	15	200	T40	44,20 g	100 pcs.
CK 08220	330822	330822	8	15	220	T40	48,70 g	100 pcs.
CK 08240	330824	330824	8	15	240	T40	53,15 g	100 pcs.
CK 08260	330826	330826	8	15	260	T40	57,07 g	100 pcs.
CK 08280	330828	330828	8	15	280	T40	61,34 g	100 pcs.
CK 08300	330830	330830	8	15	300	T40	64,95 g	100 pcs.
CK 10160	331016	331016	10	18	160	T40	54,00 g	50 pcs.
CK 10180	331018	331018	10	18	180	T40	60,90 g	50 pcs.
CK 10200	331020	331020	10	18	200	T40	66,57 g	50 pcs.
CK 10220	331022	331022	10	18	220	T40	77,30 g	50 pcs.
CK 10240	331024	331024	10	18	240	T40	78,35 g	50 pcs.
CK 10260	331026	331026	10	18	260	T40	84,53 g	50 pcs.
CK 10280	331028	331028	10	18	280	T40	90,55 g	50 pcs.
CK 10300	331030	331030	10	18	300	T40	96,85 g	50 pcs.
CK 10320	331032	331032	10	18	320	T40	103,10 g	50 pcs.
CK 10340	331034	331034	10	18	340	T40	109,23 g	50 pcs.
CK 10360	331036	331036	10	18	360	T40	114,55 g	50 pcs.
CK 10380	331038	331038	10	18	380	T40	120,73 g	50 pcs.
CK 10400	331040	331040	10	18	400	T40	126,93 g	50 pcs.
CK 12160	331216	331216	12	24	160	T40	73,42 g	50 pcs.
CK 12180	331218	331218	12	24	180	T40	82,00 g	50 pcs.
CK 12200	331220	331220	12	24	200	T40	89,90 g	50 pcs.
CK 12220	331222	331222	12	24	220	T40	98,06 g	50 pcs.
CK 12240	331224	331224	12	24	240	T40	106,00 g	50 pcs.
CK 12260	331226	331226	12	24	260	T40	114,60 g	50 pcs.
CK 12280	331228	331228	12	24	280	T40	122,55 g	50 pcs.
CK 12300	331230	331230	12	24	300	T40	127,20 g	25 pcs.
CK 12320	331232	331232	12	24	320	T40	136,16 g	25 pcs.
CK 12340	331234	331234	12	24	340	T40	144,64 g	25 pcs.
CK 12360	331236	331236	12	24	360	T40	152,89 g	25 pcs.
CK 12380	331238	331238	12	24	380	T40	161,11 g	25 pcs.
CK 12400	331240	331240	12	24	400	T40	168,85 g	25 pcs.

C10B21

NEW

5.04

Wkręt do izolacji z łbem talerzowym • Vrut na izolaci s talířovou hlavou • Skrutka pre izoláciu s tanierovou hlavičkou
 Zavrtanj za izolaciju sa tanjurastom glavom • Tányér fejű szigetelő csavar • Hoț-șurub de dulgherie pentru izolație cu cap în formă de disc
 Шуруп самонарезающий для изоляции (головка с прессшайбой) • Дърводелски болт с цилиндрична глава с кръстат шлиц • Tornillo para aislamiento con cabeza de disco
 Screw for insulation with disc head • Vis pour l'isolation à disque plat • Dämmstoffschraube mit Tellerkopf

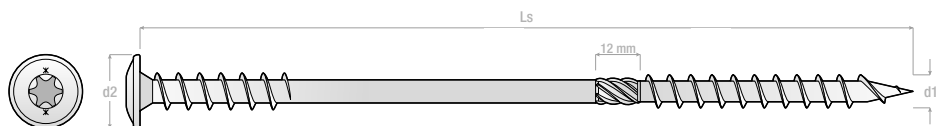
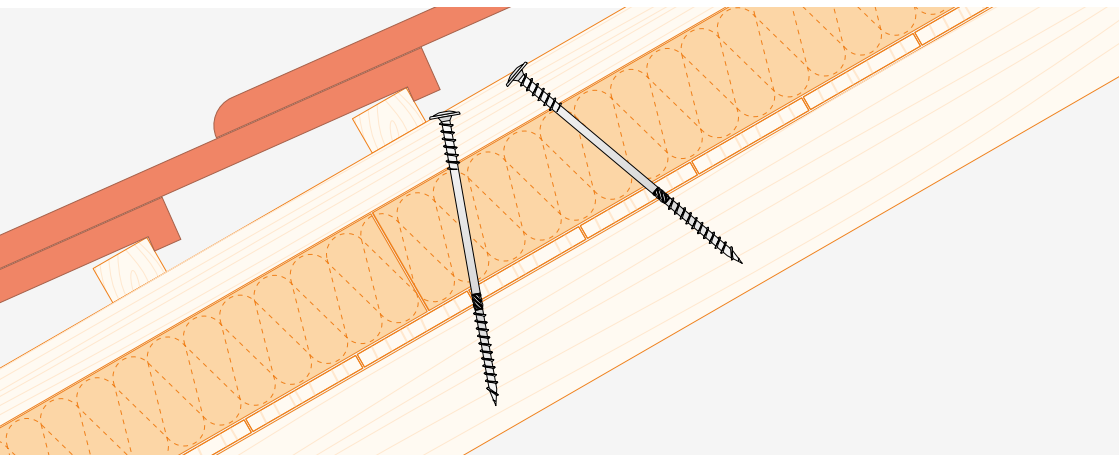

WKT



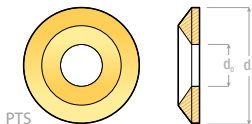

symbol	art. №		[mm]			TORX	🧴	📦
	new	old	d1	d2	Ls			
WKT 08165	340816	-	8	16	165	T40	39,60 g	50 pcs.
WKT 08195	340819	-	8	16	195	T40	46,80 g	50 pcs.
WKT 08225	340822	-	8	16	225	T40	54,40 g	50 pcs.
WKT 08275	340827	-	8	16	275	T40	64,00 g	50 pcs.
WKT 08302	340830	-	8	16	302	T40	70,00 g	50 pcs.
WKT 08335	340833	-	8	16	335	T40	77,20 g	50 pcs.
WKT 08365	340836	-	8	16	365	T40	83,60 g	50 pcs.
WKT 08397	340839	-	8	16	397	T40	90,00 g	50 pcs.
WKT 08435	340843	-	8	16	435	T40	98,40 g	50 pcs.
WKT 08235	340823	-	8	16	235	T40	55,20 g	50 pcs.
WKT 08255	340825	-	8	16	255	T40	59,60 g	50 pcs.

NEW
5.05

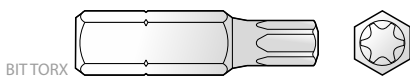

symbol	art. №		[mm]			
	new	old	d _o	d _i		
PTS 6	3920	392001	7,8	19,5	7 g	100 pcs.
PTS 8	3921	392101	9	25	13 g	100 pcs.
PTS 10	3922	392201	12	32	25 g	100 pcs.



symbol	art. №			
	new	old		
BIT TORX T20	3900	390001	5 g	10 pcs.
BIT TORX T25	3901	390101	5 g	10 pcs.
BIT TORX T30	3902	390201	6 g	10 pcs.
BIT TORX T40	3903	390301	6 g	10 pcs.

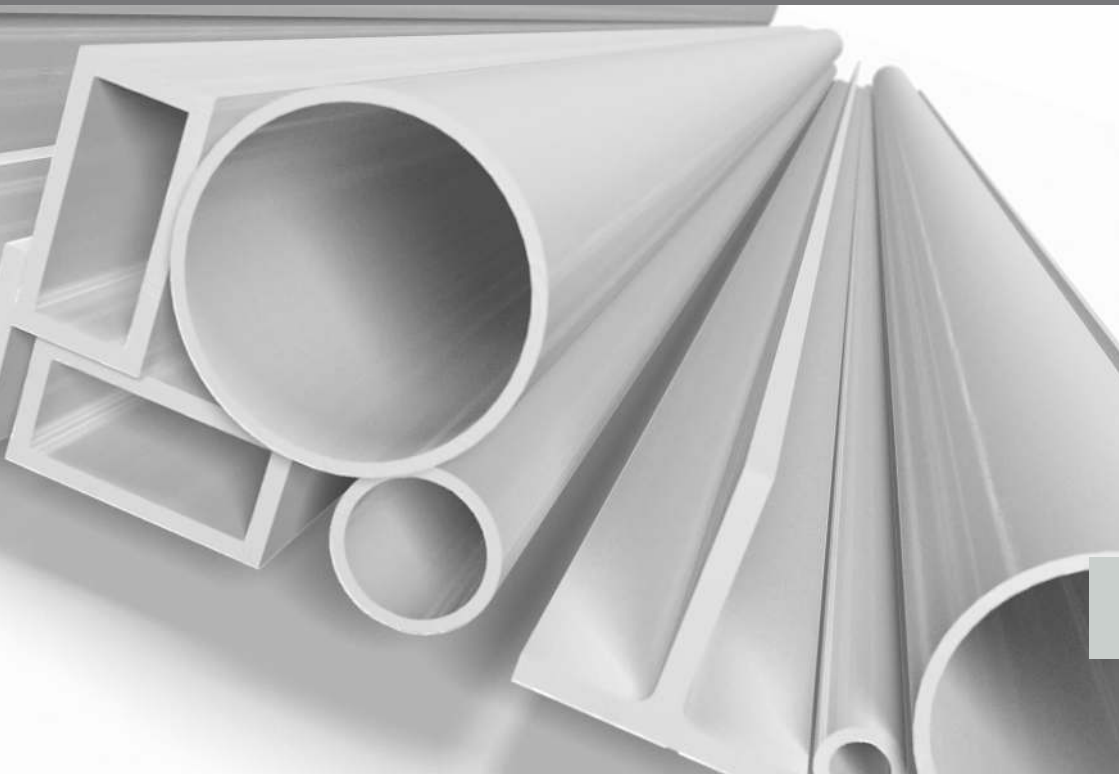

PROFILE ALUMINIOWE

HLINÍKOVÉ PROFILY

HLINÍKOVÉ PROFILY

PROFILI

PROFILOK

PROFILURI DIN ALUMINIU

ПРОФИЛИ

АЛУМИНИЕВИ ПРОФИЛИ

PERFILES DE ALUMINIO

PROFILES

PROFILÉS ALUMINIUM

PROFILE

dmxsystem.com



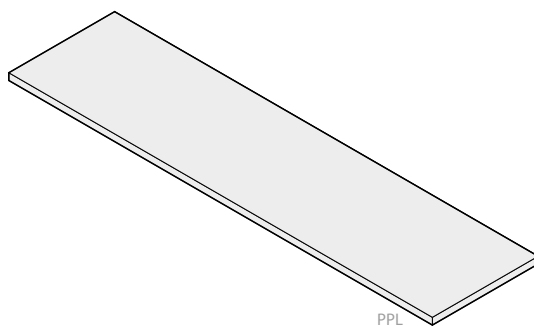

Profil aluminiowy płaskownik • Páska anodovaná • Páska
 Profil-ravni • Profil aluminium lapos • Profil din aluminiu platbandă
 Профиль алюминиевый плоский • Плоськ алуминиев профил • Perfil Plano
 Profile - flat • Profilé alu - méplat • Aluminium Profil - Flachstange

PPL





PPL

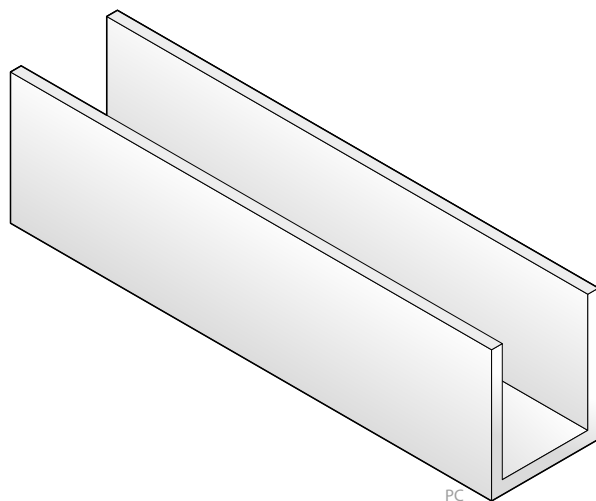

symbol	art. №		≠	[mm]			
	new	old		a	b		
PPL 1	73011	730111	5,0	20	1000	324 g	8 pcs.
PPL 2	73031	730311	3,0	25	1000	202 g	8 pcs.
PPL 4	73001	730011	3,0	40	1000	324 g	8 pcs.
PPL 6	73032	730351	3,0	25	2000	404 g	4 pcs.

anodizing aluminium



symbol	art. №		≠	[mm]		c		
	new	old		a	b			
PC 1	75001	750011	1,0	8	8	1000	60 g	8 pcs.
PC 3	75151	751511	1,5	10	10	1000	120 g	8 pcs.
PC 5	75161	751611	2,0	12	12	1000	190 g	8 pcs.
PC 7	75091	750911	2,0	15	15	1000	230 g	8 pcs.
PC 11	75101	751011	2,0	20	10	1000	210 g	8 pcs.
PC 13	75111	751111	2,0	20	20	1000	310 g	8 pcs.
PC 15	75171	751711	2,0	25	15	1000	280 g	8 pcs.
PC 25	75092	750951	2,0	15	15	2000	460 g	4 pcs.
PC 31	75112	751151	2,0	20	20	2000	620 g	4 pcs.
PC 33	75172	751751	2,0	25	15	2000	560 g	4 pcs.

anodizing aluminium

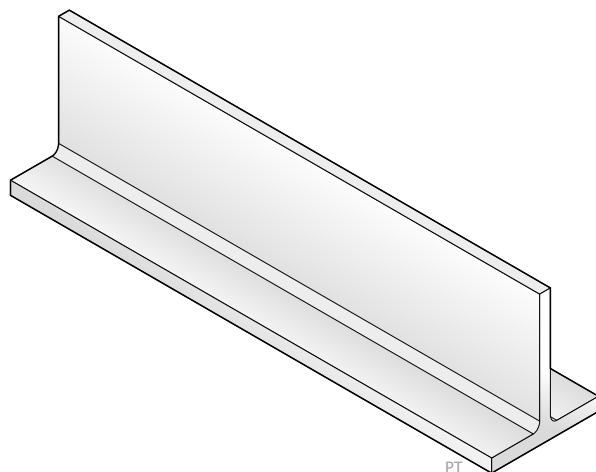

Profil aluminiowy teownik • Profil T anodovaný • Profil T
 Profil -T • Profil aluminium T • Profil din aluminiu profilul T
 Профиль алюминиевый тавр • Алюминиев профил, Т-образен • Perfil barra T
 Profile - T bar • Profilé alu - en T • Aluminium Profil - Quadrat-T

PT



PT



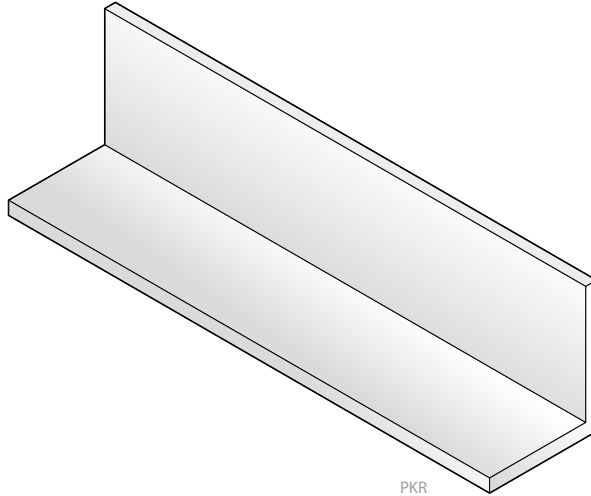

symbol	art. №		≠	[mm]		c		
	new	old		a	b			
PT 3	76021	760211	2,0	20	20	1000	220 g	8 pcs.
PT 4	76031	760311	2,0	25	25	1000	260 g	8 pcs.
PT 10	76022	760251	2,0	20	20	2000	440 g	4 pcs.

anodizing aluminium



PKR





symbol	art. №		≠	[mm]		c		
	new	old		a	b			
PKR 3	74021	740211	1,5	15	15	1000	120 g	8 pcs.
PKR 5	74041	740411	2,0	20	20	1000	250 g	8 pcs.
PKR 6	74051	740511	2,0	25	25	1000	270 g	8 pcs.
PKR 7	74061	740611	2,0	30	30	1000	320 g	8 pcs.
PKR 9	74081	740811	3,0	40	40	1000	620 g	8 pcs.
PKR 13	74022	740251	1,5	15	15	2000	240 g	4 pcs.
PKR 15	74042	740451	2,0	20	20	2000	500 g	4 pcs.
PKR 16	74052	740551	2,0	25	25	2000	540 g	4 pcs.
PKR 17	74062	740651	2,0	30	30	2000	640 g	4 pcs.

anodizing aluminium

Profil aluminiowy kątownik nierównoramienny • Úhelník nerovnoramenný anodovaný • Uholník nerovnoramenný
 Profil-ne jednaki ojažani ugao • Profil aluminium "I" • Profil din aluminiu șablon de unghiuri neechilaterale
 Профиль алюминиевый не равносторонний • Ъглов неравнораменен алуминиев профил • Perfil Rectangular
 Profile - non even-armed square • Profilé alu - cornière non isocèle • Aluminium Profil - Winkel, ungleichschenkelig

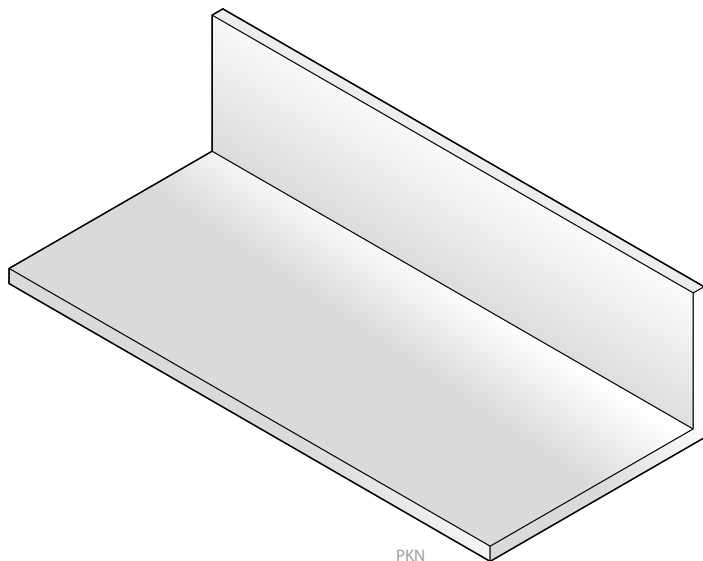
PKN



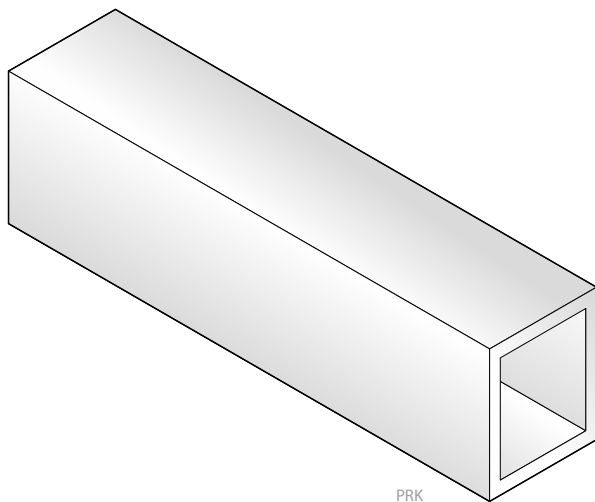

symbol	art. №		≠	[mm]		c		
	new	old		a	b			
PKN 2	74211	742111	2,0	20	10	1000	150 g	8 pcs.
PKN 3	74221	742211	2,0	20	15	1000	180 g	8 pcs.
PKN 5	74261	742611	2,0	30	20	1000	260 g	8 pcs.
PKN 7	74251	742511	2,0	40	20	1000	310 g	8 pcs.
PKN 8	74301	743011	2,0	50	25	1000	390 g	8 pcs.
PKN 10	74281	742811	3,0	40	60	1000	790 g	8 pcs.
PKN 13	74212	742151	2,0	20	10	2000	300 g	4 pcs.
PKN 16	74262	742651	2,0	30	20	2000	520 g	4 pcs.
PKN 18	74252	742551	2,0	40	20	2000	620 g	4 pcs.

anodizing aluminium



PRK



symbol	art. №		≠	[mm]		c		
	new	old		a	b			
PRK 2	77001	770011	1,0	15	15	1000	150 g	8 pcs.
PRK 3	77021	770211	1,5	20	20	1000	300 g	8 pcs.
PRK 4	77031	770311	1,5	25	25	1000	370 g	8 pcs.
PRK 8	77002	770051	1,0	15	15	2000	300 g	4 pcs.
PRK 9	77022	770251	1,5	20	20	2000	600 g	4 pcs.
PRK 10	77032	770351	1,5	25	25	2000	740 g	4 pcs.

anodizing aluminium

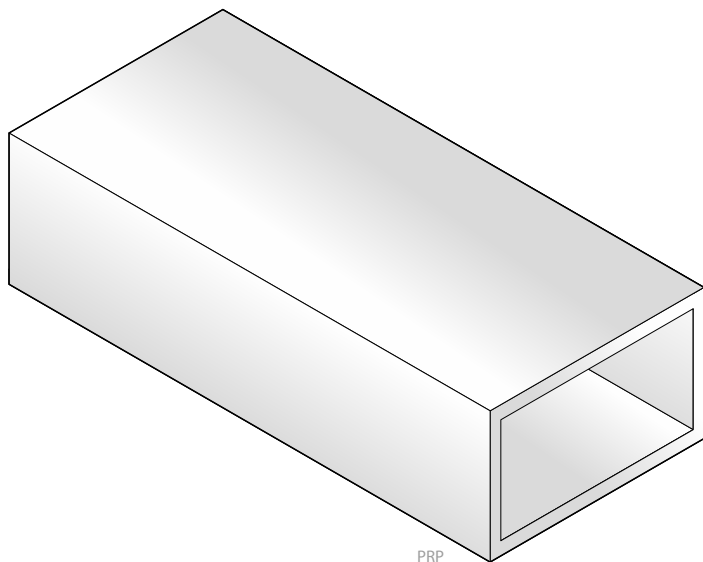

Profil aluminiowy rura prostokątna • Trubka obdĺnikov anodovan • Trubka obdĺznikov
 Profil-pravougaonik • Profil aluminim tglalap alak • Profil din aluminiu eav dreptunghiular
 Профиль алюминиевый прямоугольный • Алюминиев профил правоъгълна тръба • Perfil tubo rectangular
 Profile - rectangular tube • Profile alu - tube rectangulaire • Aluminium Profil - Rechteckrohr

PRP





PRP

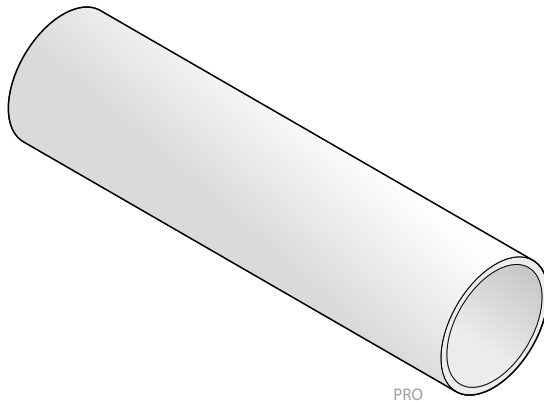

symbol	art. N		≠	[mm]		c		
	new	old		a	b			
PRP 1	77151	771511	1,5	20	10	1000	220 g	8 pcs.
PRP 4	77121	771211	1,5	50	20	1000	720 g	8 pcs.

anodizing aluminium



symbol	art. №		≠	[mm]			
	new	old		ø	a		
PRO 2	77211	772111	1,0	8	1000	60 g	8 pcs.
PRO 3	77221	772211	1,0	10	1000	80 g	8 pcs.
PRO 4	77231	772311	1,0	12	1000	90 g	8 pcs.
PRO 6	77321	773211	1,0	16	1000	130 g	8 pcs.
PRO 7	77251	772511	1,0	20	1000	160 g	8 pcs.
PRO 16	77222	772251	1,0	10	2000	160 g	4 pcs.

anodizing aluminium

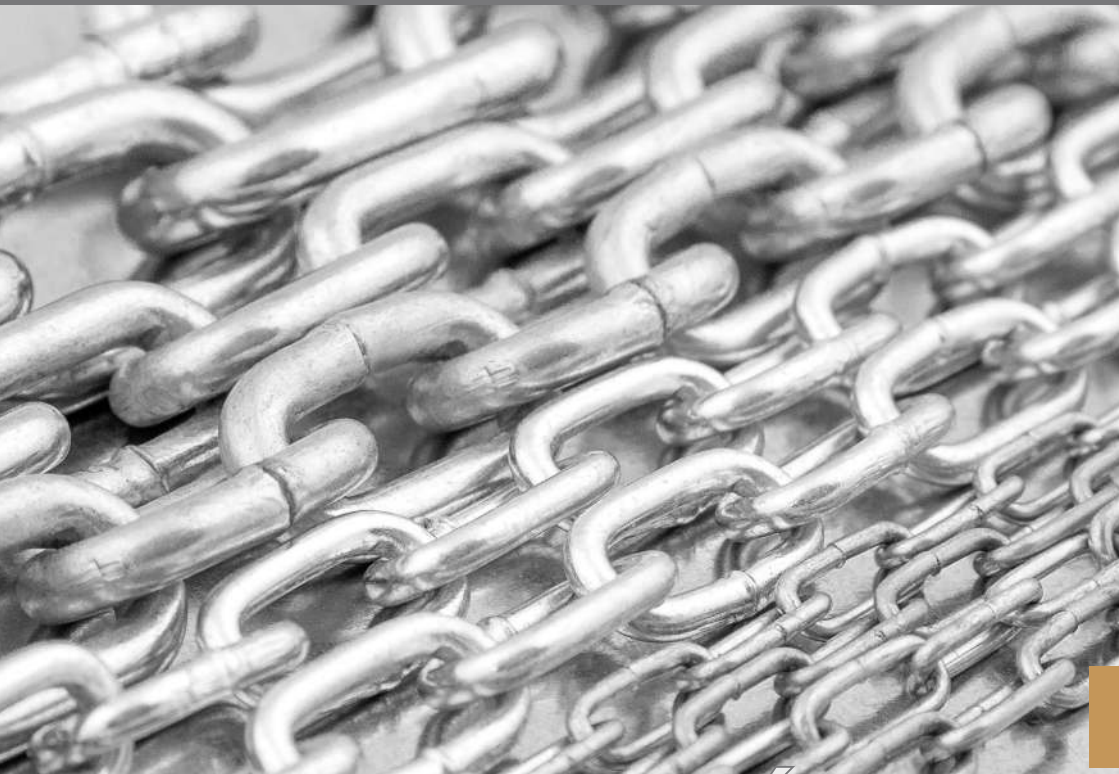

LINY · ŁAŃCUCHY

LANA · ŘETĚZY

LANÁ · ŘEŤAZE

KONOPCI · LANCI

KÖTELEK · LÂNCOK

FRÂNGHII · LANŢURI

КАНАТЫ · ЦЕПИ

ВЪЖЕТА · ВЕРИГИ

CABLES · CADENAS

ROPES · CHAINS

CORDES · CHAINES

SEILE · KETTEN

Lina pleciona z rdzeniem PPF • Lano pletené s jádrem PPF • Lana pletené s jadrom PPF
 Pleteno uže sa PPF jezgrom • PPF magú fonott kötél
 Плетеный канат с основой из ППФ • Cable trenzado con el núcleo PPF
 Woven rope with PPF core • Corde cannée à noyau PPF • Flechtseil mit PPF-Kern

XPPF



symbol	art. №				
XPPF 2	701002	2 mm	600 m	4 g	1 spool
XPPF 3	701003	3 mm	600 m	6 g	1 spool
XPPF 4	701004	4 mm	400 m	10 g	1 spool
XPPF 5	701005	5 mm	300 m	13 g	1 spool
XPPF 6	701006	6 mm	300 m	20 g	1 spool
XPPF 8	701008	8 mm	300 m	39 g	1 spool
XPPF 10	701010	10 mm	200 m	53 g	1 spool
XPPF 12	701012	12 mm	150 m	66 g	1 spool

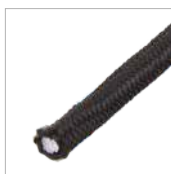





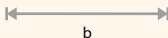

symbol	art. №				
XGM 4	702004	4 mm	100 m	8 g	1 spool
XGM 6	702006	6 mm	100 m	20 g	1 spool
XGM 8	702008	8 mm	100 m	31 g	1 spool
XGM 10	702010	10 mm	100 m	35 g	1 spool

Sznurek murarski • Šňůra zednická • Šnúra murárska
 Zidarsko uže • Kőműves zsinég
 Шнур-причалка • Cable de albanileria
 Bricklaying string • Corde de maçon • Maurerschnur

XSM



symbol	art. №	colour			
XSM 100	703001		100 m	75 g	6 spools
XSM 50	703005		50 m	50 g	6 spools
XSM 100	703101		100 m	75 g	6 spools
XSM 50	703105		50 m	50 g	6 spools



symbol	art. №				
XLJ 8/10	704108	8 mm	10 m	260 g	1 pcs.
XLJ 10/10	704110	10 mm	10 m	474 g	1 pcs.
XLJ 12/10	704112	12 mm	10 m	580 g	1 pcs.
XLJ 8/30	704308	8 mm	30 m	780 g	1 pcs.
XLJ 10/30	704310	10 mm	30 m	1420 g	1 pcs.
XLJ 12/30	704312	12 mm	30 m	1740 g	1 pcs.

Dratwa • Provaz • Dratva
Špaga • Varrótú
Бечевка • Sedal
Twine • Fil poissé • Kordel

XDR



symbol	art. №	colour		
XDR 100	705010		100 g	8 spools
XDR 100	705110		100 g	8 spools

7.05







symbol	art. №	colour		
XSK 500	705250		500 g	4 spools

Sznurek do suszenia prania • Šňůra na prádlo • Šnúra na sušenie prania
Uže za sušenje veša • Ruhaszárító kötél
Бельевая веревка • Cable para el secado de ropa
String for drying clothes • Corde à linge • Wäscheleine

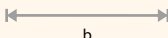



XSP

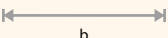

symbol	art. №	colour			
XSP 15	707001		15 m	42 g	10 spools

7.07







symbol	art. №	colour			
XSS 30	707103		30 m	77 g	6 spools

Sznurek z tworzywa • Šňůra plastová • Šnůra z umelej hmoty
Sintetičko uže • Műanyag zsineg
Бечевка синтетическая • Cable para las resinas
Plastic string • Corde en plastique • Kunststoffschnur

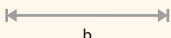
XST







symbol	art. №	colour			
XST 150	707215		150 m	150 g	4 spools

7.09

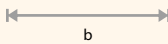
XST



symbol	art. №	colour			
XSW 500	707350		500 m	500 g	1 spool



Łańcuch gospodarczy krótkoogniowy D1 • Řetěz hospodářský s krátkými články D1 • Retěz hospodárska s krátkymi ohnivami D1
 Lanac sa kratkim karikama D1 • Rövidszemű D1-es háztartási lánc
 Цепь хозяйственная короткозвенная D1 • Cadena de granja de eslabones cortos
 Short-link farm chain D1 • Chaîne à petits maillons D1 • Kurzgliedrige Kette D1

XLG



symbol	art. №				
XLG D1/2	711002	2 mm	100 m	69 g	1 spool
XLG D1/4	711004	4 mm	40 m	304 g	1 spool
XLG D1/5	711005	5 mm	50 m	457 g	1 spool
XLG D1/6	711006	6 mm	36 m	724 g	1 spool



symbol	art. №			
XKR 6/60	721006	6 mm 60 mm	27 g	10 pcs.



Karabińczyk z zabezpieczeniem • Karabina s pojistkou • Karabínka s poistkou
Spojnica za lanac sa osiguračem • Karabiner biztosítással
Карабин с муфтой • Mosquetón de seguridad con protección
Clip hook with protection • Mousqueton avec une protection • Karabinerhaken mit Sicherung

XKRZ



symbol	art. №			
XKRZ 6/60	721106	6 mm 60 mm	28 g	10 pcs.



symbol	art. №			
XSR 8 O/H	723008	8 mm 118 mm	145 g	5 pcs.

Zacisk liny • Lanová svorka • Prítlačný úchyt lana
Stezač konopca • Kötél szorító
Канатный зажим • Sujetador para cable
Rope clamp • Serrage de la corde • Seilklemme

XZL



symbol	art. №	ø		
XZL 6	722006	6 mm	16 g	10 pcs.



symbol	art. №			
XSZ 8	724008	8 mm 16 mm	56 g	10 pcs.



domax

DOMAX Sp. z o.o.

al. Parku Krajobrazowego 109
Łężyce, 84-207 Koleczkowo, Polska
tel.: +48 58 665 82 22
fax: +48 58 665 81 20
e-mail: domax@domax.com
www.domax.com

DOMAX Slovenská Republika

Kancelária a sklad:
Puste 848
013 22 Rosina
tel.: +421 (0) 41 598 3002
fax: +421 (0) 41 598 3000
e-mail: obchod@domax.com

DOMAX Česko s.r.o.

Staroměstská 534
739 61 Třinec
tel.: +420 558 273 401
email: obchod@domax.cz

DOMAX Republika Srbija

DMX System doo
Industrijska zona bb
11500 Obrenovac
tel.: +381 11 875 5064
tel.: +381 65 245 7294
tel.: +381 65 245 7293
office@dmxsystem.com

DOMAX Espana

David Jaén Segura
tel.: +34 977 18 29 44
fax: +34 977 69 16 49
movil: +34 607 90 48 26
e-mail: d.jaen@domax.com

DOMAX in Latvija

Inara Lisa
Lubanas 125A-9, Riga, LV-1021
tel/fax.: +371 66066594
mobile: +371 28334477
e-mail: birojs@domax.com

DOMAX в России

Москва, СВАО,
тел.: (+7) 495 221 73 50
тел./факс: (+7) 495 221 73 50
e-mail: info@domax-rus.ru

DOMAX в Беларуси

ООО «Домак Систем»
220131, г. Минск, ул. Гало, д.148, к.1,
оф.1.
тел./факс: +375 (017) 392 78 93
тел. моб.: +375 (29) 185 08 85
тел. моб.: +375 (29) 340 04 32
e-mail: info@domax.by

DOMAX В България

Конкурент ООД
9000 Варна, ЗПЗ,
бул. "Д-р Атанас Москов" 22
тел.: (+359) 52 730 500
факс: (+359) 52 730 900
e-mail: krepo@krepo.com

DOMAX в Молдове

Група компаний LIDER SRL
"Profmet Grup"
г. Кишинев
ул. Петриканская 33
тел.: (+373) 84-46-71
факс: (+373) 84-46-72
e-mail: krepelj@lider.md

DOMAX в Украине

Група компаний LIDER OOO
"Лидер Буд"
Украина, г. Борисполь
ул. Киевский шлях, 47
моб.: (00380) 067-216-92-74
тел.: (00380) 0459-55-48-80
e-mail: office@liderbud.com.ua

Wydanie: 08-2014

Wszelkie prawa autorskie zastrzeżone.

Kopowanie lub przetwarzanie katalogu w całości lub w części, w jakiegokolwiek formie bez zgody producenta jest zabronione.

Domax Sp. z o.o. All rights reserved.

Copying or reproducing of this catalogue in any form without prior written permission of Domax Sp z o.o. is strictly prohibited.

dmxsystem.com